

PCPSION

SERIES

7

USER GUIDE

© Copyright Pison Computers Plc 1999.

All rights reserved. This manual and the programs referred to herein are copyrighted works of Pison Computers Pl.C, London, England. Reproduction in whole or in part, including utilisation in machines capable of reproduction or retrieval, without the express written permission of the copyright holders is prohibited. Reverse engineering is also prohibited. The information in this document is subject to change without notice. Pison and the Pison logo are registered trademarks, and Pison Series 7, Series 5mx, Series 5, Series 3mx, Series 3c, Series 3a, Series 3, Siena and PsiWin are trademarks of Pison Computers Pl.C. Some names referred to are registered trademarks.

© Copyright Symbian Ltd 1999.

All rights reserved. The EPOC machine contains the EPOC operating system and software, and PsiWin 2 contains the EPOC CONNECT software that is the copyrighted work of Symbian Ltd, London, England. EPOC and the EPOC logo are registered trademarks of Symbian Ltd.

The IrDA Feature Trademark is owned by the Infrared Data Association and is used under license therefrom.

© Copyright Monotype Typography Ltd 1997.

All rights reserved. EPOC contains the fonts Arial®, Times New Roman® and Courier New, products of Monotype Typography Ltd, Surrey, England.

Arial® Arial is a trademark of the Monotype Corporation registered in U.S. Patent and Trademark Office and certain other jurisdictions.

Times New Roman® Times New Roman is a trademark of the Monotype Corporation registered in U.S. Patent and Trademark Office and certain other jurisdictions. Monotype® Monotype is a trademark of Monotype Typography Limited registered in U.S. Patent and Trademark Office and certain other jurisdictions.

© Lernout & Hauspie Speech Products N.V. 1995.

All rights reserved. International CorrectSpell™ English spelling correction system © 1995 by Lernout & Hauspie Speech Products N.V. All rights reserved. Reproduction or disassembly of embodied algorithms or database prohibited. UK English Concise International Electronic Thesaurus Copyright © 1995 by Lernout & Hauspie Speech Products N.V. All rights reserved. Reproduction or disassembly of embodied programs and databases prohibited.

Part of the software in this product is © Copyright ANT Ltd. 1998. All rights reserved.

Incorporates MPPC® compression from Hi/In™.

Stac ®, LZS ®, © 1996, Stac, Inc., © 1994, 1996 Microsoft Corporation. Includes one or more U.S. Patents: No. 4701745, 5016009, 5126739, 5146221, and 5414425. Other patents pending.

Incorporates LZS® compression from Hi/In™. Hi/In ®, LZS ®, © 1988-98, Hi/In, Includes one or more U.S. Patents: No. 4701745, 5016009, 5126739, 5146221, and 5414425. Other patents pending. All notices of Hi/In's patents shall be made in accordance with 35 U.S.C Sec. 287(a).

Version 1.0, August 1999

Part no. 6131-0004-01

English

FCC Information for the USA

Radio and Television Interference

This equipment radiates radio frequency energy and if not used properly - that is, in strict accordance with the instructions in this manual - may cause interference to radio communications and television reception.

It has been tested and found to comply with the limits for a Class B digital device pursuant to part 15 of the FCC Rules. These are designed to provide reasonable protection against harmful interference in a residential installation. However, there is no guarantee that interference will not occur in a particular installation. If this equipment does cause harmful interference to radio or television reception, which can be determined by turning the equipment off and on, the user is encouraged to try to correct the interference by one or more of the following measures:

- Reorient or relocate the receiving antenna.
- Increase the separation distance between the equipment and the receiver.
- If you are using the equipment with a mains adaptor, plug it into an outlet which is on a different circuit from that to which the receiver is connected.
- Consult an experienced radio/TV technician for help.

Important

This equipment was tested for FCC compliance under conditions that included the use of shielded cables and connectors between it and the peripherals. It is important that you use shielded cable and connectors to reduce the possibility of causing radio and television interference. Shielded cables, suitable for the Series 7, can be obtained from an authorised Psion dealer.

If the user modifies the equipment or its peripherals in any way, and these modifications are not approved by Psion, the FCC may withdraw the user's right to operate the equipment.

In the USA

For customers in the USA, the following booklet prepared by the Federal Communications Commission may be of help: "How to Identify and Resolve Radio-TV Interference Problems". This booklet is available from the US Government Printing Office, Washington, DC 20402 - Stock No 004-000-00345-4.

Emissions information for Canada

This Class B digital apparatus meets all requirements of the Canadian Interference-Causing Equipment Regulations.

Cet appareil numérique de la classe B respecte toutes les exigences du Règlement sur le matériel brouilleur du Canada.

FCC Declaration of Conformity

Product: Series 7

Models: I6M/32M

This device complies with part 15 of the FCC rules. Operation is subject to the following two conditions:

1. This device may not cause harmful interference.
2. This device must accept any interference received, including interference that may cause undesired operation.

The Product is for home or office use.

Responsible party:

Psion Inc.
150 Baker Avenue,
Concord,
MA 01742, USA.
Tel: +1 978 371 0310
Fax: +1 978 371 9611

Infrared device safety

CLASS 1 LED PRODUCT

This product includes an Infrared device for transmitting and receiving files from devices supporting the IrDA format. Although this invisible beam is not considered harmful, and complies with EN60825-1 (IEC825-1), we recommend the following precaution: when the Infrared device is transmitting:

- do not stare into the Infrared beam
- do not view directly with optical instruments

No parts in the device may be serviced by the user.

CE marking

When used in a residential, commercial or light industrial environment the product and its approved UK and European peripherals fulfil all requirements for CE marking.

CONTENTS

Getting started 1

About the Series 7	1
Where things are	2
About PsiWin 2	5
Using this manual	5
Switching on	6
Turning on & off	6
The screen	7
Finding & using the pen	7
First steps	7
Things to do first!	15
Things to do next!	18

Files, folders & programs 21

Moving around	21
Opening files, folders & programs	23
Closing programs/files	23
Creating new folders	24
Creating new files	25
Browsing folders	27
Finding files and folders	28
Using passwords	29
Changing file attributes	29
Managing folders	30
Checking memory use	31
Additional disks & programs	32

Word 33

Entering text	33
Finding & replacing text	34
Changing the appearance of text	34
Formatting paragraphs	35
Using styles	37
Document outlines	38
Information from other programs	40
Spell checking	41
Creating a new file	41
File templates	41
Saving Word files	43
How the page looks	43
Printing	44

Sheet 45

Moving around	46
Entering information	46
Performing calculations	47
Using ranges	49
Changing how information is displayed	50
Sorting information	50
Changing the number format	51
Graphs	52
Printing from Sheet	54

Contacts 55

Adding a contact	55
Looking at your contacts	55
Editing & deleting contacts	57
Contact labels	57
Exchanging contacts	59
Printing contacts	59

Agenda 61

Moving around	62
Adding appointments & events	62
Viewing entries	64
Entry symbols	65
Birthdays and anniversaries	65
Reminders for entries - alarms	65
Finding entries and dates	67
Changing and deleting entries	68
Repeating entries	69
Lists and things to do	69
Information from other programs	72
Customising Agenda	74
Agenda files	74
Printing Agenda entries	75
Synchronising with a PC Scheduler	76

Setting up Web and Email 77

Where to find out more	77
Before you start... ..	77
Setting up your Series 7	79
Setting up Email on your Series 7	83

Web 92

Read this first	92
Navigating the Web	92
Saving pages	94
Customising	95
Using bookmarks	96
Using forms	97
Loading images	98
Downloading files	99
Cache & memory usage	100
Using proxy servers	100
Customising the display	101
Keypresses	101
Status information	102
Fonts	103
Sending mail from a Web page	104
Finding text on a Web page	104
Plain text authentication	105
Cookies	105
Viewing HTML source	106
Using plug-ins	106

Email 107

Read this first	107
Finding your way around	107
Managing emails	107
Local folders	108
Writing an email	109
Sending email	111
Receiving email	112
Viewing an email	113
Replying to & forwarding emails	113
Attaching files to messages	115
Disconnecting	116

Calc..... 117

General calculations	118
Scientific calculations	119
Displaying numbers	124

Jotter 125

Adding a note	125
Formatting the text	126
Inserting other information	127
Finding a note	128
Deleting entries	128
Customising Jotter	129
Jotter files	130
Printing Jotter entries	130

Time 131

Using alarms	131
Using the map	136
Customising Time	138
Setting summer time	139

Data 141

Adding an entry	142
Looking at entries	143
Sorting entries	144
Customising Data	144
Finding an entry	144
Changing or deleting entries	144
Customising the database	145
Printing Data entries	146

Sketch 147

Drawing sketches	148
Changing a sketch	149
Adding text	150
Inserting “clipart”	151
Printing sketches	151
Sketch files	152

Spell	153
Spell-checking and correction	153
Using the thesaurus	154
Solving anagrams	154
Finding missing letters - Xword	155
Adding words to Spell	156
Record	157
Recording a sound	157
Playing sounds	158
Bombs- the Series 7 game	161
Programming	163
Creating & running OPL programs	163
PsiWin	165
Installing PsiWin	165
Where can I find PsiWin?	165
Getting help	166
Getting connected	167
Working with your files	169
Backing up your Series 7	171
Synchronizing your Series 7	172

Printing	173
Setting up the printer	173
Selecting the printer model	176
Page setup	176
Previewing a document	177
Printing a document	178
Infrared	179
Selecting data to transfer	180
Transferring the information	180
Dialling	183
Setting up	184
Entering phone numbers	184
Dialling phone numbers	185
Customising your Series 7	187
Creating your own wallpaper	187
Recording your own alarms	187
Customising the System screen	187
Expanding your Series 7	189
CF Card	189
RAM cards	191

Care & safety	193
Powering the Series 7	194
Changing the batteries	195
Battery safety	196
Prolonging battery life	196
Security & backups	197
Troubleshooting	199
Appendices	203
Character set	203
Specification	205
Index	207

GETTING STARTED

This manual contains information about the Series 7 and the PC connectivity software PsiWin 2.

About the Series 7

The programs on the Series 7 include:

- **Word**, a word processor for writing letters and other documents.
- **Sheet**, for spreadsheets, tables, and graphs.
- **Contacts**, an address book.
- **Agenda**, a diary program for appointments and lists of things to do.
- **Email**, for sending and receiving email, SMS and fax messages.
- **Web**, for browsing the World Wide Web.
- **Calc**, a calculator with general and scientific features.
- **Jotter**, a notebook for jotting down ideas quickly.
- **System**, the Series 7's control centre. You can tap the System icon at any time to move to the System screen.
- **Time**, for alarms and a world map with international times and dialling codes.
- **Data**, a customisable database program.
- **Sketch**, for drawing pictures.
- **Bombs**, a game of logical thinking.
- **Record**, for recording and editing voice memos and sounds.
- **Program**, the editor in which you can create programs using the built-in programming language.
- **Spell**, for checking spelling, thesaurus, solving anagrams and crossword clues.
- **Comms**, for terminal emulation and file transfer.

Where things are

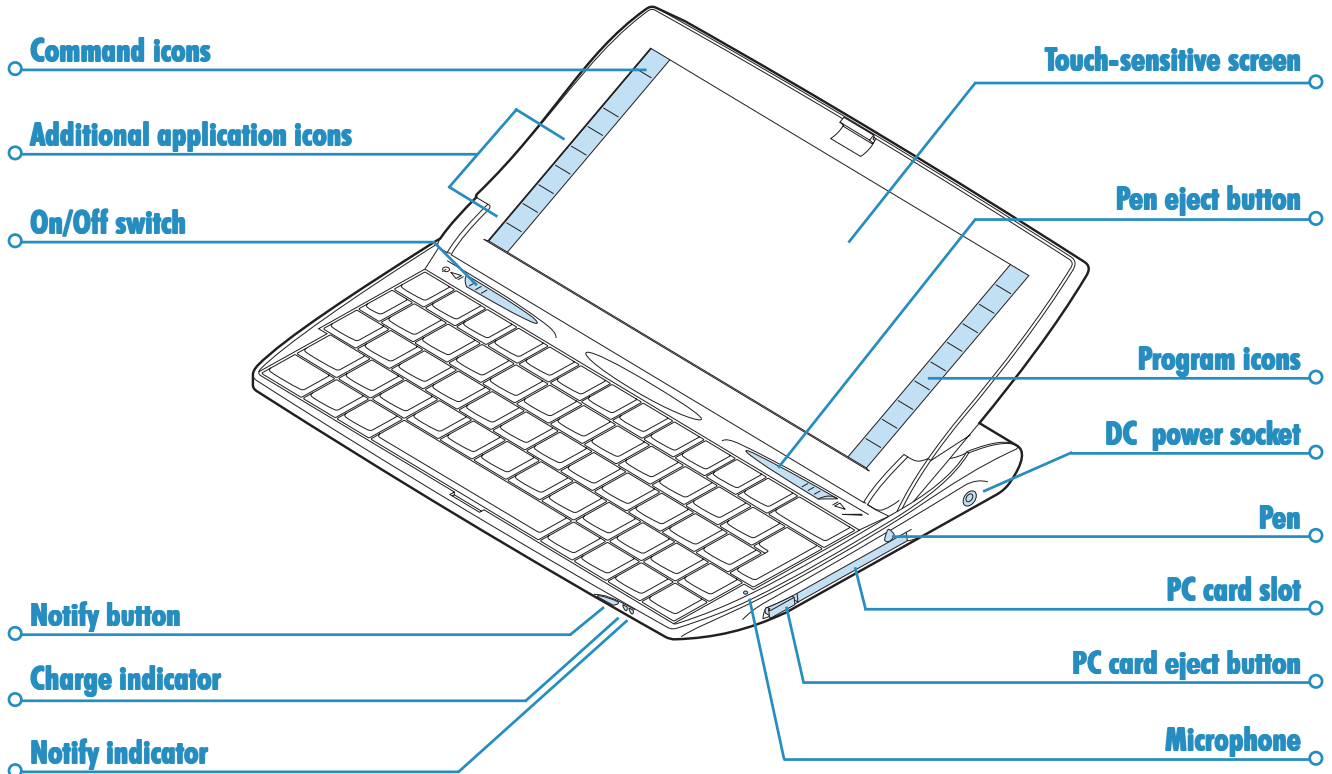

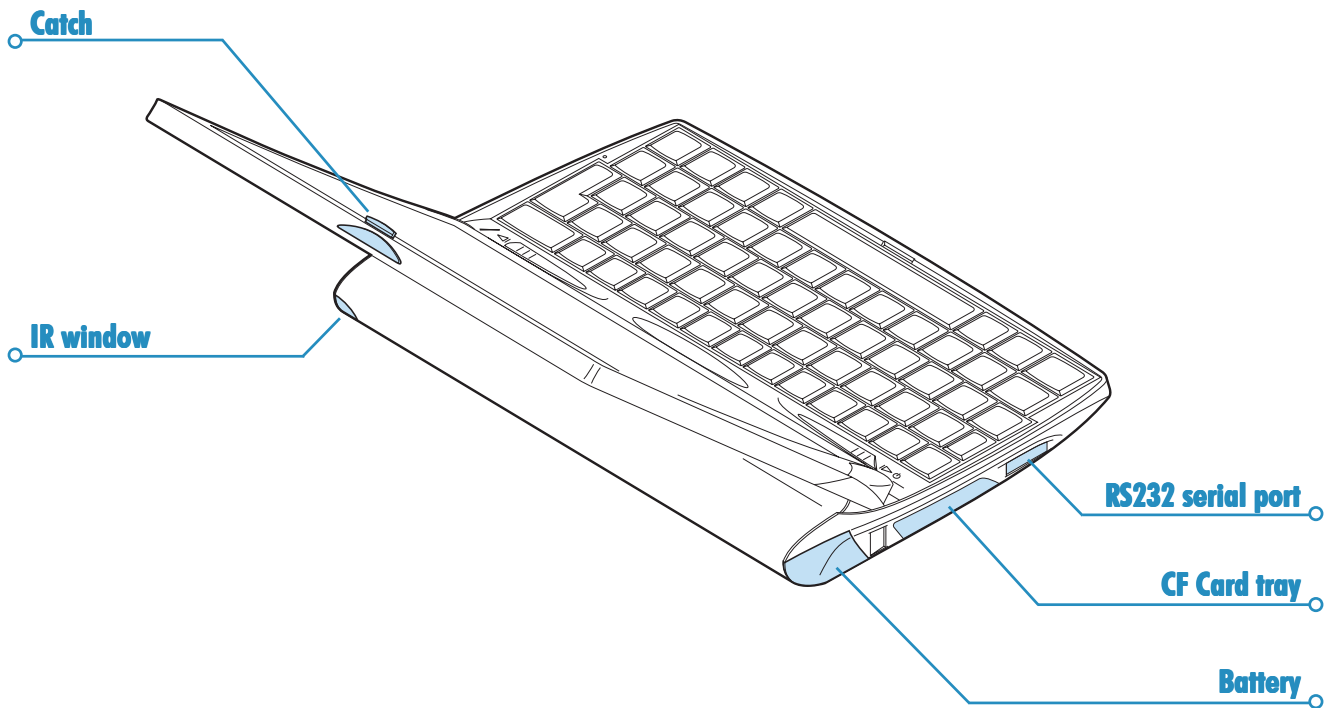

Reset button

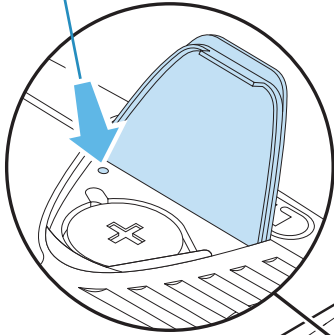

Docking connector

Lithium backup battery door

Loudspeaker

About PsiWin 2

You can use the PC connectivity software PsiWin 2 to integrate the Series 7 with PCs running Windows 95/98 or NT 4.0. By connecting the Series 7 to a PC with a Docking cable and running PsiWin, you can:

- **View your Series 7 files** from Windows Explorer by using the 'My Psion' icon which is added to the PC's Desktop. The 'My Psion' icon gives you access to all of PsiWin's powerful file management facilities for your Series 7 files.
- **Upgrade from an earlier model of Psion handheld computer to a Series 7** as a one-stop process. All your files will be copied from your old Psion (Series 3/3a/3c/3mx/5/5mx or Siena), converted to the Series 7 file formats on the PC, then copied to your Series 7.
- **Drag and drop files** between the Series 7 and the PC in the same way that you would between PC drives, and they will be **automatically converted** to the appropriate file format at the same time.
- **Synchronize Agenda files and your address book** on the Series 7 with PC agendas (applications) and contact managers to keep them in step with each other.
- **Back up** your Series 7 files to the PC, then **restore** them from the PC to the Series 7 again should you ever need to.
- **Print** files on your Series 7 to a printer connected directly to your PC, or available to your PC via a network.

Using this manual

This manual gives an overview of all the Series 7 functions and features to give you an idea of what you can do; for more detailed information than is given here, refer to the Series 7 and PsiWin on-line help.

- Read the first part of this chapter to find out how to get the Series 7 ready for use: fit the batteries, switch on, adjust the screen, find and practice with the pen and start using the software.
- Read 'Things to do first!' to find out the essential things to do when you first get your Series 7 - this covers setting the time and date, setting your "home city" (so that the time differences from your home are calculated correctly) and setting owner information and a machine password.
- Move on to 'Things to do next!' for a list of the programs and a brief overview of what else you may want to do when you first use your Series 7 - instructions for using PsiWin to connect to your PC and perform backups and more ideas for customising your Series 7.
- Read the 'Files, folders and programs' chapter for more information about how to enter and manage the information on your Series 7.
- Refer to the 'Troubleshooting' chapter if you have any problems using the Series 7.

Switching on

Fitting the batteries

Before you can use the Series 7 you must fit both batteries, as shown below.

The Series 7 is powered by:

- a powerful Lithium Ion rechargeable battery pack.
- a Lithium CR2032 backup battery (supplied). This preserves your information should you need to change the main battery.

Take care when replacing batteries!

You will lose information if you remove both batteries at the same time, or allow both batteries to become completely run down. The Series 7 will warn you when its batteries are getting low, in plenty of time to change/charge them. See the 'Care & safety' chapter for more about battery safety, and details of how to change the batteries.

You can also power the Series 7 from the mains. You should **ONLY** use Psion approved mains adaptors. Contact your Psion distributor or local Psion retailer for more information.

Turning on & off

- **To switch on:** slide the on/off switch to the left or press the Esc key. When you first do this, you'll see the System screen.

Note: The Series 7 will automatically switch on when an alarm rings.

- **To switch off:** hold down the Fn key and press the Esc key. You can switch off at any time. You do not have to save your information first, as it is automatically saved for you.

Note: If you do not press a key, the Series 7 will automatically switch off after 3 minutes to save battery power. Switch it on again, and you can continue from where you left off.

Can I switch on the Series 7 by tapping the screen?

Yes. You can set up your Series 7 to switch on when you tap the touch-sensitive screen. To do this, open the **Switch on/off** icon from the **Control Panel** in the System screen.

Prise open backup battery door and fit backup battery exactly as shown

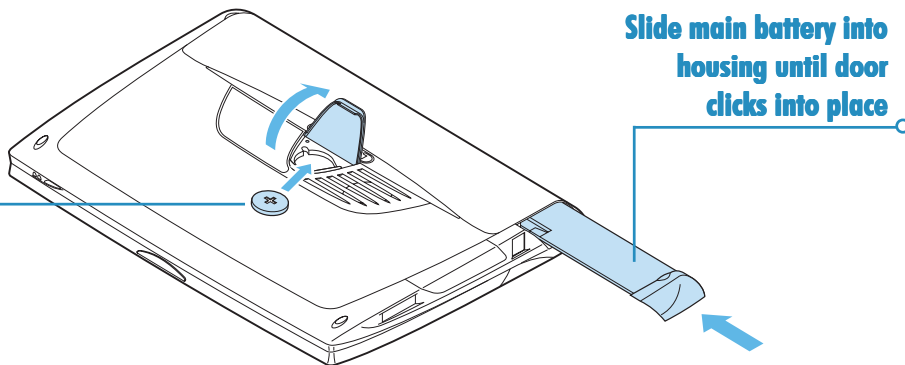

Slide main battery into housing until door clicks into place

The screen

Adjust the screen contrast by holding down the Fn key and pressing the ‘,’ (⌘-) or ‘.’ (⌘+) key.

Change the size of the text on the screen using the **Zoom in** and **Zoom out** commands.

Adjust the screen brightness by holding down the Fn key and pressing the Spacebar. Each press of the Spacebar increases brightness by one ‘step’.

Important: Note that battery life is considerably reduced when the brightness is increased.

Finding & using the pen

The pen is located in a holder at the right, just behind the keyboard. To remove it, slide the pen eject button to the right. To replace it, push it back in and it will click into place.

Tap lightly on the screen using the pen. It’s OK to use your fingers to tap on the screen, though it is best to use the pen to avoid fingerprints or smudges on the screen. **Do not** tap the screen with any object that has a sharp tip or you may damage the screen. Don’t use any type of ink pen, as the ink may be impossible to remove. See the ‘Care & safety’ chapter for instructions on how to clean the screen.

You can usually tap on an item with the pen to select or change it. For example, you can tap on:

- the program icons, to open a program.
- the command icons, for “shortcuts” to System functions, e.g. the menu bar, cutting and pasting, Infrared, zooming in and out.

Note: If the screen doesn’t respond to your taps, you may need to re-calibrate it. You can do this by opening the **Screen** icon from the Control panel.

Most of the things you can do with the pen have an equivalent keyboard combination, so you can use the pen, the keyboard, or a combination of both methods.

First steps

When you first switch on the Series 7, you will see the System screen. This is the “desktop” where you can view your files and folders, and change settings that control how the Series 7 works.

- All the information you enter into the Series 7 is contained in files; their names are displayed in the System screen, beside icons that represent the programs that created them.
- All your files are stored in folders. When you start using the Series 7, the contents of the ‘Documents’ folder is displayed.
- The System screen’s “Title bar” shows you which folder is currently displayed on the screen. When you start you are in the ‘Documents’ folder on the “C (Internal) drive”.

You can have as many folders as you wish, and create folders within other folders. Folders can contain files created in a variety of programs; they are not restricted to files from a single program. See ‘Files, folders & programs’ for details of managing files and folders.

Navigating between files & folders

- Tap on a folder icon to move to that folder, tap on the Close folder icon to close it and move back up a level.
- Tap on a file to select it, tap again to open it. If the filename is displayed in bold, the file is open, and tapping it will move straight to the file.

See ‘Files, folders & programs’ for more information about manipulating files and folders.

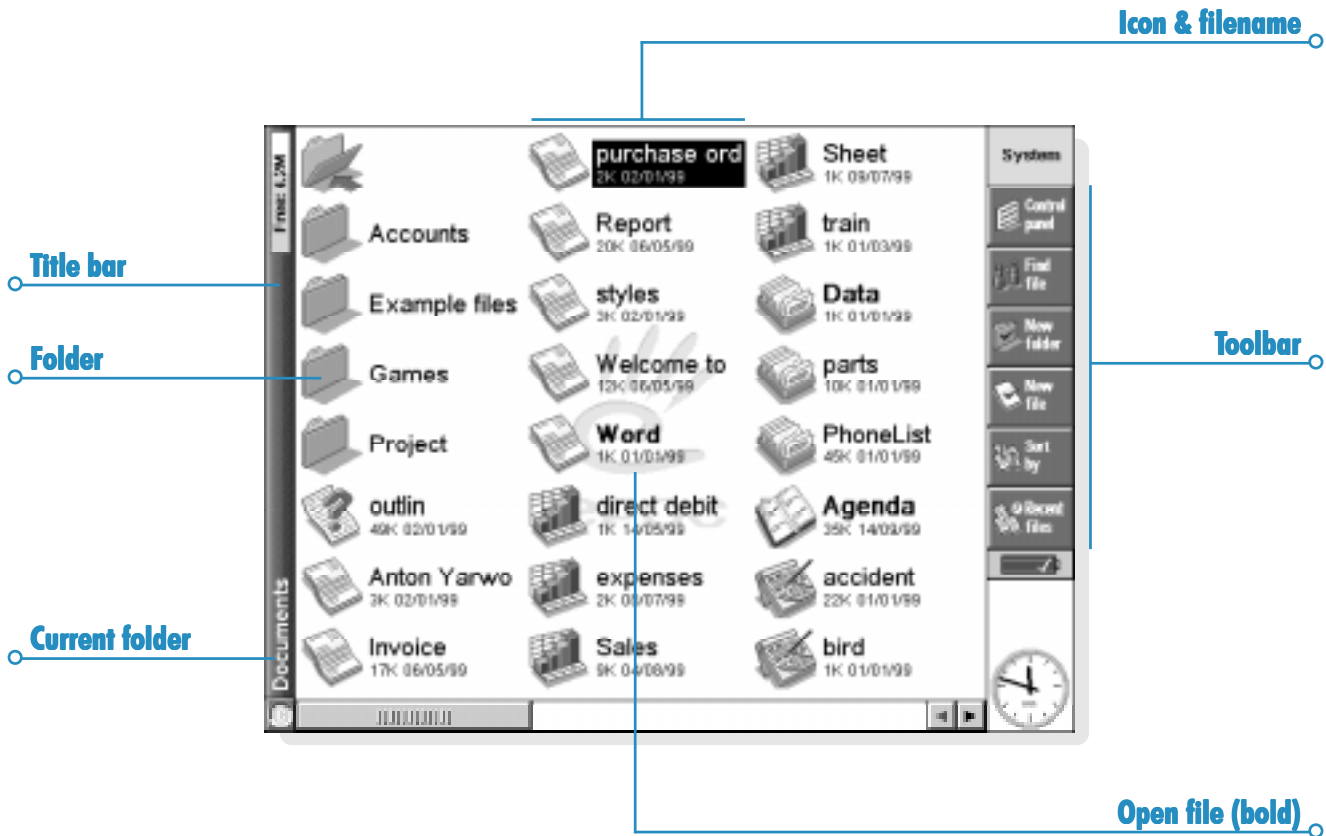

Starting programs

When you open or move to a file, the correct program for this file is started automatically. You can also start programs by tapping on the appropriate “program icon” (the icon in the row of pictures at the bottom of the screen).

- Tap the System icon at any time to move to the System screen.
- Tap on Extras to display the “Extras bar”, which contains more program icons.

You don't have to close one program before opening another, just tap on another program icon, and that program will open too.

You can see what files and programs are open from the System screen by using the **List open files** command from the **File** menu, or by tapping on the name in the top right corner of the screen.

Programs & files



When you run a program, it will usually display the currently open file, or the file that you last looked at. If you want to write a new letter, draw a new picture, create a new database and so on, you'll need to create a new file for the particular program involved.

- **To create a new file:** select the command on the **File** menu. The file will now be created, and the current file will be closed and saved at the same time. You can start entering your information.
- You can also use this command in the System screen to create a new file. Usually, this creates a file using the standard settings; creating a file from within a program creates a file which already has any settings or preferences you have set up in the program.
- It is a good idea to keep related files together in a folder, to make the files easier to find later. See 'Files, folders & programs' for details of how to manage your files and folders.

See the 'Which program to use?' section for more about using the programs.

Entering information

You can enter information and complete tasks using the pen or the keyboard. You can usually select a menu command to perform each task.

- Press the Menu key or tap on the  command icon to see the available commands on the “Menu bar”.
- Tap on the menu names and commands, or use the arrow keys to move around the menus. Tap on commands marked with a  or press the right arrow key to see further commands.

Note: You can press the shortcut key combinations shown next to the commands as a quick way of selecting them, e.g. Ctrl+M, means hold down the Ctrl key and press the M key at the same time.

- A menu command with three dots at the end means that selecting the command will display a “dialog” where you enter more information.
- If a menu command is grey, it means that it’s not currently available; e.g. you cannot “Copy” unless you have first selected something to copy.
- To toggle Capslock mode, so that characters appear in uppercase, press Fn + Tab.
- To toggle Numlock mode, so that you can use the embedded orange numeric keys, press Shift + Menu.

Using dialogs

A “dialog” appears when you need to make selections and enter further information. You can move between dialog items by tapping on them, or using the up and down arrow keys. Dialogs contain one or more of the following elements:

Text box: where you just type in your information.

List box: where you select from a number of options. You will see left and right arrows around the current selection; you can change the selection by tapping on the arrows, by pressing the left and right arrow keys, or by typing the first letter of the option you want. You can usually tap in the box or press the Tab key to see a list of the available options.

Check box: where you make a choice between selecting an option or not selecting it. Just tap on the check box, or press the left and right arrow keys to add or remove a tick.

Radio buttons: where you make one choice from a number of options. Just tap on an option, or use the left and right arrow keys to make a selection.

- If a dialog line is grey, it is currently not available, usually because you have to select something else first. For example, if you have not ticked the box to set an alarm for an Agenda entry, the lines to set the alarm time and date are grey. Some dialog lines only appear when another option has been chosen.

Some dialogs comprise a number of “pages”, each page has a “tab” at the top. Tap on the tab or move the highlight to the tab name, to go to that page. You can also move a dialog around the screen by holding the pen on the dialog title bar and dragging it across the screen.

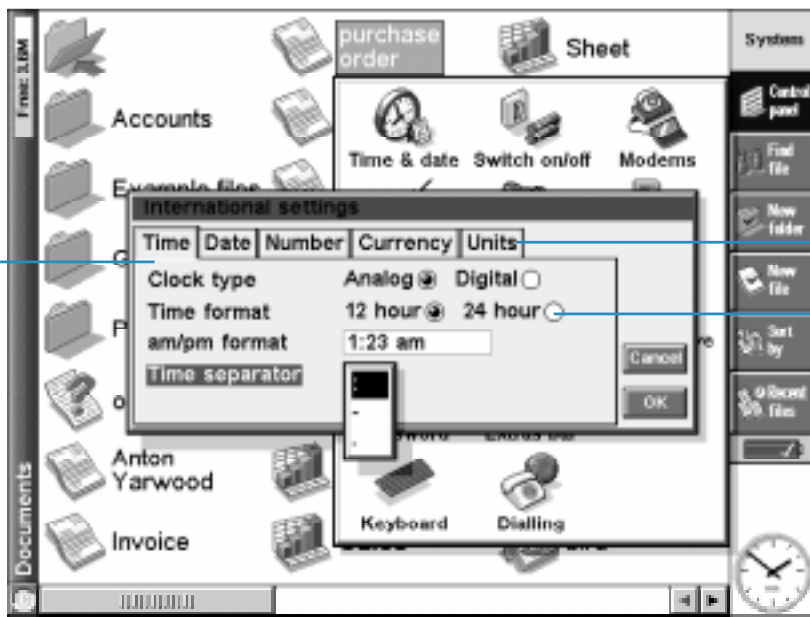

Dialog page

Tabs for other dialog pages

Radio button



How do I display a calendar?

In most dialogs in which you can type a date, move to the date line then tap again or press Tab to display a calendar.

Today's date is circled, and the date currently displayed in the dialog is highlighted. To select another date, move to the date you want and press Enter. Use the buttons on the top line, or further presses of the Tab key, to display a three month or twelve month calendar. Use the "dog ears" to move between the pages of the calendar.

You can also display a calendar from the Agenda program. See the 'Agenda' chapter for more details.

Dialog buttons

Dialogs may have on-screen buttons. Tap on the button or use the keypress combination under it. Some buttons have a standard keypress equivalent:

- Usually, you can tap the **OK** button or press the Enter key if you want to save information and remove the dialog.
- Tap the **Cancel** button or press the Esc key if you want to remove the dialog without saving the information.
- For dialogs that ask a question, you can tap the **Yes** button or press the 'Y' key for 'yes'; tap the **No** button, press the 'N' key or press the Esc key for 'no'.

Copying information between programs

You can insert information created in one program into a different program. This is known as "inserting" an "object".

For example, you may want to add a picture to a letter you are writing. To do this, write the letter as normal using the Word program. Then, while in Word, select the menu command to insert a sketch. This will start the Sketch program, where you can create the picture. Close Sketch when you have finished and the picture will be inserted in your letter.

Sometimes the object you insert can be displayed as an icon, perhaps if you insert a large amount of Word text in an Agenda entry. Alternatively, you may prefer to see the actual information added, e.g. a map to view in the Word file.

For example, you may wish to:

- insert tables of figures and graphs from Sheet into a Word file. You can add labels and titles to the graph in Sheet before inserting it in the Word file.
- keep a map of how to find a restaurant as a sketch, perhaps attached to an Agenda entry for the day that you're going there.
- create a Sketch file of your signature, and insert the signature when you write letters in the Word processor.
- keep handwritten notes and ideas in Sketch. You can then insert them into Jotter or a Word file if necessary.

Displaying Help

You can display help at any time, and from any program. Help information is contained on a series of “help cards” in one large database that looks similar to the databases that you create in the Data program. Help is not specific to the program that you are using; wherever you are, you can just type a “clue” to search for the information you need.

Note: The on-line help contains more detailed information than is included in this manual.

- **To display help:** Hold down Fn and press ‘/’ ; the key has “Help” printed on it.
- **To search for help about something:** simply type your clue into the **Find:** box, and press Enter. If the **Quickfind** button is selected the display will show a list of Help cards with the clue in the title or initial description. Alternatively, if the **Find in all** button is selected, the display will list all cards with the clue in the text. To move between cards, tap on the **Prev** or **Next** buttons, press Enter, or use the left and right arrow keys.
- **To show help for a particular program:** type the program name followed by an exclamation mark, e.g. type ‘Agenda!’ or ‘Contacts!’ to only show help for these programs.
- **To look through the help text:** drag the scroll bar on the side of the Help card, or use the up and down arrow keys.
- **To print the current Help card:** tap the **Print** button on the Toolbar or select **Print** from the **File** menu.
- **To type in another search word:** press Esc, and then type in the word to search for as before. To use one of the last five search words again, tap on the button next to the **Find:** box, or press Tab and select the word you want to use.
- **To return to the program you were using:** tap the **Go back** button on the Toolbar, or tap the program’s icon. You can return to the Help card you were viewing by simply pressing Fn and ‘/’ again.

Note: You can highlight text in a Help card using the pen or keyboard, and copy it to use in a file of your own. Copy the text by selecting the **Copy** command from the **Edit** menu. Then go to your own file, and paste it in.

Help topic card

Text found by search

Search clue

The screenshot displays the help interface on an EPOC machine. On the left, a help topic card titled "Word: Quick start" is shown. The card contains text explaining that Word is the EPOC machine's word processor and lists several features and instructions, such as "Use Word to write letters, memos, faxes, or an entire novel" and "Format text quickly and easily by tapping buttons on the Top toolbar". A search result is visible at the bottom of the card, showing "Find: insert" with a small icon. On the right, a card browser lists various help topics, including "Word: Quick start", "Bullets & symbols (Word)", "Combining sketches", "Functions (Sheet)", "Inserting cells, rows & column", "Inserting objects (Agenda)", "Inserting objects (Data)", "Inserting objects (ArBar)", "Inserting objects (Word)", "Inserting page breaks (Word)", "Inserting pictures from clipart (ArBar)", "Inserting text (Sketch)", "Objects", and "Ranges (Sheet)". Below the list is a "Help" button and a "Go back" button. At the bottom right, there is a "View prefs" button, a "Print" button, and a clock icon. The page number "1/14" is visible at the bottom right of the screen.

Help topic titles in card browser

Go back without closing help

Things to do first!

This section describes what you need to do to set up your Series 7. You should:

- set the current time and date, so that you can use the Agenda programs and set alarms.
- set your “Home city”, so that the Series 7 can display the correct time differences and dialling codes for other places in the World.

It is also a good idea to:

- enter owner information, so that your Series 7 can be returned if you lose it.
- set a password for your machine, so that other people cannot access your information.

Setting the time, date & the Home city

1. In the System screen, tap on the **Control panel** button on the Toolbar, or select the command from the **Tools** menu.
2. Tap the **Time & date** icon, or move the highlight to it using the arrow keys and press Enter.
3. You will see a “dialog” in which you can set the time and date, your home city and summer times around the world. Tap the **Time & date** button. Move the highlight in the **Time** and **Date** lines by tapping on the part you want to change, or by using the arrow keys. Type the date or time, press ‘P’ for p.m. or ‘A’ for a.m.
4. Tap on the **OK** button or press the Enter key, and the time and date are saved.
5. Tap the **Home** button.
6. Select your Home city and country. To do this:
 - Start typing in the name of your home city, or tap on the arrow symbols or press the left and right arrow keys until you find the city you want.
 - If your home city is not listed, select a city that is nearby for now (adding a city is described in the ‘Time’ chapter).
7. Tap on the **OK** button or press the Enter key, and your home city is saved. Tap **Close** or press Enter to remove the dialog and return to the Control panel. Press Esc to return to the System screen.

Note: The Series 7 can use a 12 hour clock (midnight is 12:00:00 a.m.) or a 24 hour clock. Refer to the ‘Time’ chapter for details of how to change these settings, and how to adjust the clock for summer time.

Time & date icon

Time & date dialog

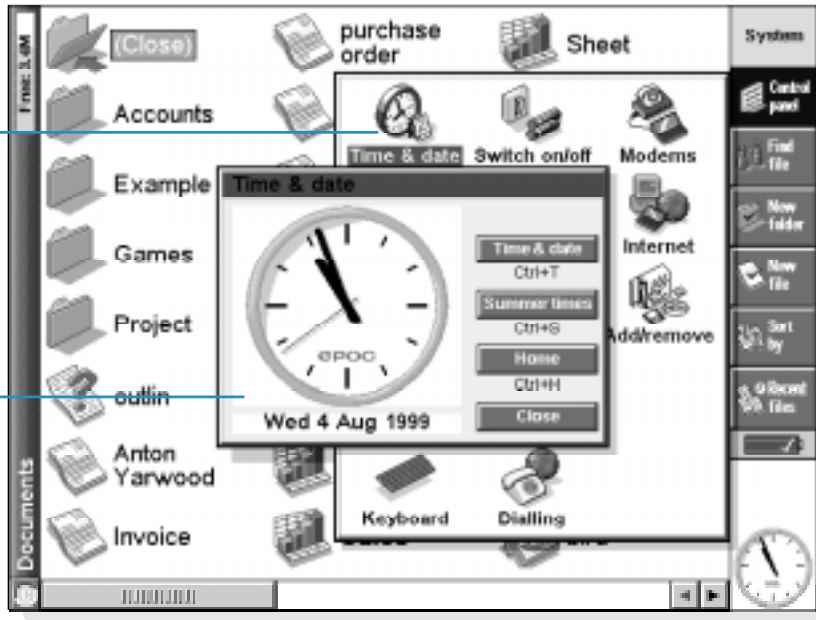

Entering owner information

It is a good idea to type your contact information as “owner information”, so that if you lose your Series 7, it can be returned when found:

1. Select the **Password** icon from the **Control panel** in the System screen, and tap the **Owner info** button in the dialog.
2. Type in your details. The labels provided are suggestions only, you can change them if you want to. It's best not to put your home address, in case your house keys are lost at the same time.
3. Set how you wish the owner information screen to be displayed, i.e.:
 - 'At switch on', if you always want to display the screen when switching the machine on.
 - 'Once per day', if you only want to see the screen once a day, the first time you switch your machine on each day.
 - 'Never', if you never want to display the screen when you switch on.

You can display the owner information at any other time using the **Owner** command on the **Information** menu in the System screen.

Setting a system password

To prevent anyone looking at the files on the Internal disk of the Series 7, set a system password which you must type in before you can use the machine.

To do this:

1. Select the **Password** icon from the **Control panel** in the System screen.
2. Tick the 'Ask for password' box so that your Series 7 requests the password when you switch the machine on.
3. Type the password twice for confirmation. Choose a password that you won't easily forget, but one that won't be easy for someone else to guess. **DON'T FORGET** your password! You will need to enter the password again if you want to change the password settings on your Series 7.

The password is now set. The next time you switch your machine on, you will have to type in the password to access your files.

If you want to switch the password off temporarily, remove the tick from the 'Ask for password' box.

Note: The system password does not protect files stored on Memory disks or files copied to other machines.

/// Important: don't forget your password!

If you have forgotten the system password then you will have to reset the machine. All the files stored on the internal disk will then be lost.

Things to do next!

This section gives a brief overview of what else you may want to do when your first use your Series 7, including:

- Ideas for how you can use the programs.
- Instructions for using PsiWin to connect to your PC and perform backups to your PC.
- Ideas for customising your Series 7.

Which programs to use?

The first things you wish to do may include:

- **entering appointments, reminders, birthdays and lists of things to do** from your old diary or time planner into the Agenda program. If you use a PC scheduler such as Microsoft Outlook or Lotus Organizer, you can use PsiWin to synchronize the information in your Psion and PC schedules to keep them both up to date.
- **entering names and addresses** from your old address book into the Series 7's Contacts address book. If you also keep names and addresses in a PC scheduler, you can use PsiWin to synchronize your Psion and PC address books so that they are both kept up to date.

- **setting a morning alarm** in the Time program. The Time program also includes a map of the world, and information about cities, world times, and national and international dialling codes.
- **entering a 'work to do list'**. This is best entered as a To-do list in Agenda. You will be able to see outstanding tasks in the Day view, set alarms to remind you to do them and cross out items when you've completed them.

You may also wish to:

- keep a meeting agenda or minutes as a memo or voice note attached to the meeting's entry in Agenda. You can then retrieve the notes by finding the meeting entry.
- keep a record of expenses in the Sheet program. Here you can search for items, add columns of numbers, or calculate totals and tax.
- keep a Data file as a "knowledgebase" of notes about a particular subject. You can keep track of references or products as you find them, and include additional information as attached "voice notes" or sketches.

Connecting the Series 7 to the PC

- Connect the smaller end of the Docking cable to the serial port on the Series 7, and the other end to a serial port at the back of the PC.

Using PsiWin

- Please see the PsiWin chapter for installation instructions. For a floppy disk version of this software, please contact your nearest Psion distributor.
- When you have installed PsiWin on the PC, the 'My Psion' icon will appear on the Windows Desktop. Just click the right mouse button on this icon to see menu options for the things that you can do. PsiWin also adds a number of commands and icons to Windows Explorer for working on Series 7 files. See the PsiWin on-line help for details of how to use PsiWin with the Series 7.

Note: The Comms program that is built into the Series 7 provides terminal emulation and file transfer to other computers. You can use it to connect the Series 7 directly to another computer, or via a modem to access electronic mail systems and bulletin boards.

A detailed User Guide for Comms is included on the PsiWin CD ROM, along with other literature that may be of interest to you.

Backing up to a PC

You can use PsiWin to back up individual files, folders, or all of the Series 7's disk to the PC.



Making regular backups.

It is a good idea to set up an "automatic backup" in PsiWin so that you can make sure your machine is backed up regularly.

Backing up to Memory Disks

You can back up individual files, individual folders or groups of files and folders to a Memory Disk. To back up the files and folders, copy them from the internal disk to a Memory Disk using the **Copy** and **Paste** commands in the System screen.

1. Select the files and folders you want to back up, then select the **Copy** command from the **Edit** menu.
2. Set the current disk to be D (i.e. the Memory disk), and select the folder you want to use for the backup on disk D.
3. Select the **Paste** command from the **Edit** menu.

Exploring the Control panel

- **To display the Control panel:** move to the System screen and tap on the **Control panel** button on the Toolbar, or select the command from the **Tools** menu. Initially, you should set up the **Time & date**, **Screen**, **Switch on/off**, and **Printer** if you intend to use one. You might also like to set up owner information and a password. You may wish to change other settings later.

When you first use your Series 7, you may wish to:

- Use the **International** icon to change settings which may vary from country to country, e.g. the currency and date formats.
- Use the **Switch on/off** icon to control how and when the Series 7 switches on and off. For example, you might like it to switch on when you tap the screen, and off when you close the case.
- Use the **Sound** icon to control the sounds that the Series 7 makes when you press keys, tap the screen and perform other actions.
- Use the **Screen** icon to change the screen contrast and brightness, or re-calibrate the touch sensitive screen if the Series 7 stops responding to your pen taps.
- Use the **Keyboard** icon to control how long you have to hold a key down before a repeat keypress occurs.
- Use the **Password** icon to set a password on your machine or enter owner information.

Control panel

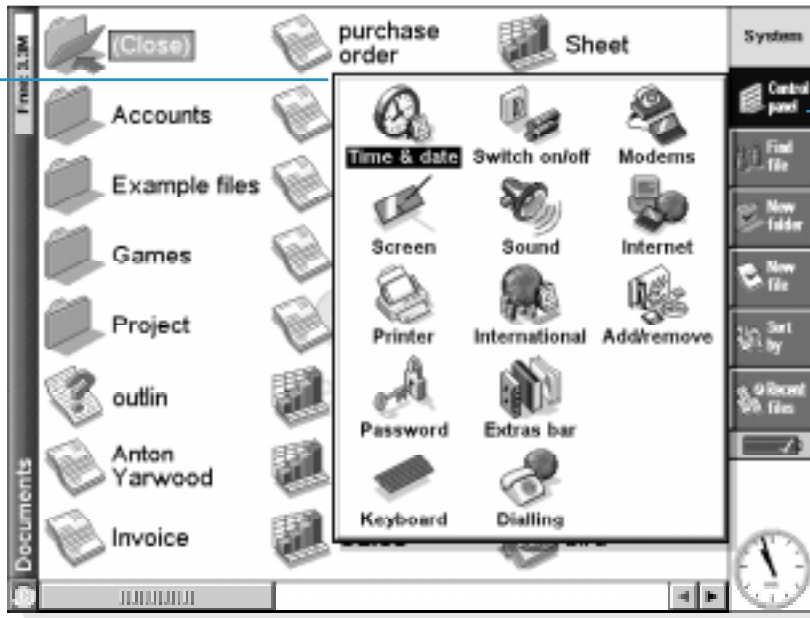

Control panel
Toolbar button

FILES, FOLDERS & PROGRAMS

The System screen is the Series 7's file manager. You will see the System screen the first time you switch the Series 7 on; at other times, just tap the System program icon to move to it.

When you first turn the Series 7 on, the name of the current folder is displayed in the Title at the left of the screen. Files are listed in columns across the screen; the icons beside their names represent the programs which are used to open them.

Moving around

- **To move the highlight between the files and folders on the screen:** tap on the names, or use the arrow keys. If there are more files in the folder than can be displayed on screen, scroll the screen using the left and right arrow keys, or the scroll bar at the bottom of the screen.

You can use a “bookmark” to tag and move to a folder that you often use. Move to the folder and select **Set bookmark** from the **Edit** menu to insert the bookmark. Later you can select **Go to bookmark** from the **Edit** menu to move back to the folder.

- **To view the files on a Memory disk:** change the current disk by tapping the disk ('C') icon in the Title bar and select the disk you want to view, or select the command for disk 'D' from the **Current disk** commands on the **Disk** menu.

Close folder

Files

Memory information



Change disk

Opening files, folders & programs

- **To open a file or folder from the System screen:** tap it twice, or highlight it and press Enter. Files that are currently open have their names displayed in bold on the System screen. Opening a file automatically saves and closes any other file that is currently open in the program.
- **To open two or more files of the same type at the same time:** hold down the Fn key while opening the second file from the System screen. Then tap the program icon to cycle through the open files.
- **To move to a program:** tap the relevant Program icon; tap the Extras icon to display more program icons. If the program is file-based, e.g. Data or Word, the program displays the last file you were looking at. You can start a new file using the **New file** Toolbar button or the command on the **File** menu (see 'Creating new files' later for more details).

Note: If the last file you were looking at has been deleted, moved or renamed, the program automatically looks for a file with a standard filename (e.g. Word, Data, Agenda and so on) in the standard folder, and opens this file instead. It will create a new file if necessary.

Note: Tap on the Extras icon to display additional icons for programs installed on your Series 7. If there are more programs than will fit on the screen, tap the **More** button.



How can I see which files and programs are open?

Select the **List open files** command from the **File** menu, or hold down the Ctrl key and tap the **System** icon. To move to a file or program in the list, highlight it and press the **Go to file** button.

Closing programs/files

- **To close the current folder:** tap on the Close folder icon at the top of the screen, or highlight it and press Enter. When you close all folders in the System screen, you move to the highest level of the disk, called the “root” of the disk.
- **To close a file:** use the **Close** command on the **File** menu, either in the program in which the file is open, or in the System screen. Any changes you have made to the file are automatically saved.

You can also close files or programs by holding down Ctrl and tapping the System icon, then using the **Close file** button in the list of open files and programs.

Creating new folders

You can keep a maximum of 64 items (each file or folder counts as one item) in the “root” (top level) of the Series 7’s internal disk. It’s best to create a number of folders in which to store all your files to prevent the top level of the System screen from becoming too full.

You might want to create some folders for work projects and others for home use. For example, you may create a folder called “House” for files relating to work on your house, and create another folder within the “House” folder called “Letters” for Word files of correspondence. Using folders in this way will also make your files easier to find.

To create a new folder:

1. Move to the folder in which you wish to create the new folder.
2. Select the **New folder** command from the Toolbar or **File** menu, and type in the folder name.

You cannot use the following characters in a folder name:

< > : / \ * ?

If you use Series 7 files with a PC, you may wish to create folders that match equivalent folders on your PC. This will make transferring files between the Series 7 and PC easier.

Creating new files

You can create files from the System screen, or from within programs. As a general rule:

- Create a file from the System screen to start with the standard Series 7 settings.
- Create a file from within a program to use the settings that are in use in the file currently open, e.g. labels in a Data file.

To create a file from the System screen:

1. Move to the folder where you wish to keep the file.
2. Select the **Create new** command from the **File** menu, then select **File**.
3. Select the program you wish to use, e.g. Word for a Word document.
4. A filename is suggested. If you do not wish to use this, type a name of your own before pressing the **OK** button.

Note: If you have an existing file already open within the program, and wish to leave it open so that you can refer to both files, hold down the Fn key while pressing the **OK** button.

What names can I use for my files & folders?

You can use most characters in file and folder names including spaces, so it is fine to have folders called, for example, “1997 Purchase Orders and Invoices”. The only characters which cannot be used in a file or folder name are / < > : \ * and ?.

The maximum length of a filename is 256 characters, although note that this includes the disk drive letter, and the names of the folders within which the file is contained (known as the “path”). The maximum length of a folder name, including the path, is 252 characters.

This will not generally be a problem, although it means that you may encounter difficulties if you use very long filenames for files which you store in folders which have long names, nested within other folders with long names, and so on. If you do exceed the maximum allowed length, rename a folder or file to a shorter name.

Important:

Note that files are not stored with a filename extension so that an Agenda file, e.g. called ‘1997’, will have the same filename as a Sheet file called ‘1997’. You **cannot** store two files with the same name in the same folder, even if the files are created using different programs. If you save a file with the same filename as a file already existing in that folder, the original file will be deleted and replaced with the new file.

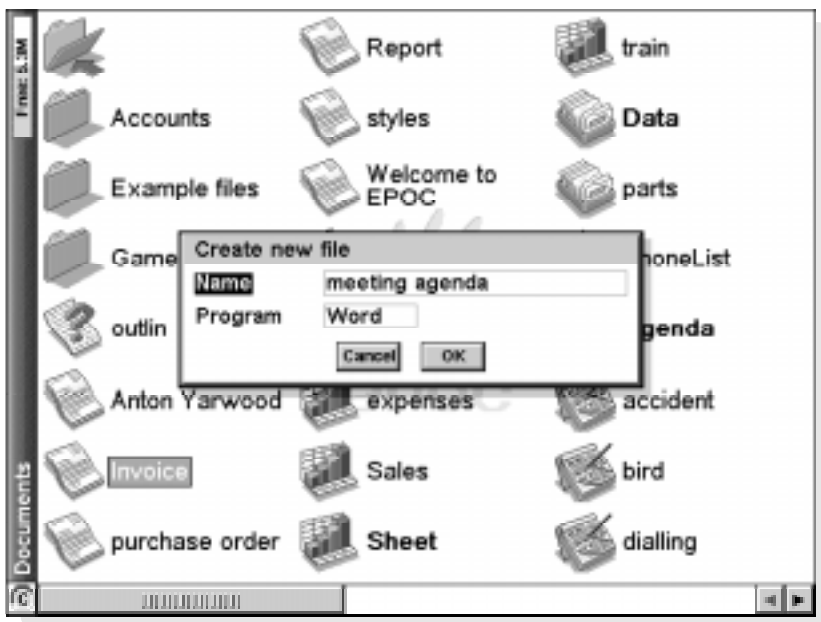

Browsing folders

A quick way to find a file is to use the **Browse folders** command on the **File** menu. This displays a Browser which shows a tree structure of all the files and folders on the current disk. You can also display the Browser by tapping the Title bar or pressing Tab in the System screen.

- **To move between files and folders in the Browser:** use the pen or arrow keys.
- **To “expand” the folder display:** highlight the folder name and tap it again or press Tab. To “collapse” the folder display, tap the folder name twice or press Tab.
- **To create a folder from the Browser:** press the **New folder** button.
- **To rearrange the order of the files in the currently highlighted folder:** press the relevant **Sort by** button.
- **To select a file from the Browser:** highlight the file and press the **OK** button. This selects the file in the System screen from where you can open it, rename it, or copy, move or delete the file.

Note: A quick way of opening a file direct from the Browser is simply to highlight it and press Enter twice.

Finding files and folders

To search for files or folders select **Find files** command on the **Edit** menu.

- If you know the name or part of the name, type it on the **Name** line; leave it blank to find all files and folders.
- To search only for files used with a specific program, select the program name on the **Program** line; select 'Any' to search for all files used with any program.
- **To sort the list** by filename, file type, file size or creation date, press the **Sort** button and choose the sorting type required. To sort the list again in reverse order, just select the same sorting type again.
- **To go to a file or folder:** highlight it and tap it again, or press Enter.

Tap **OK** to start the search. This checks all files and folders on the Internal disk and includes a Memory disk if present. The search results appear in a list.

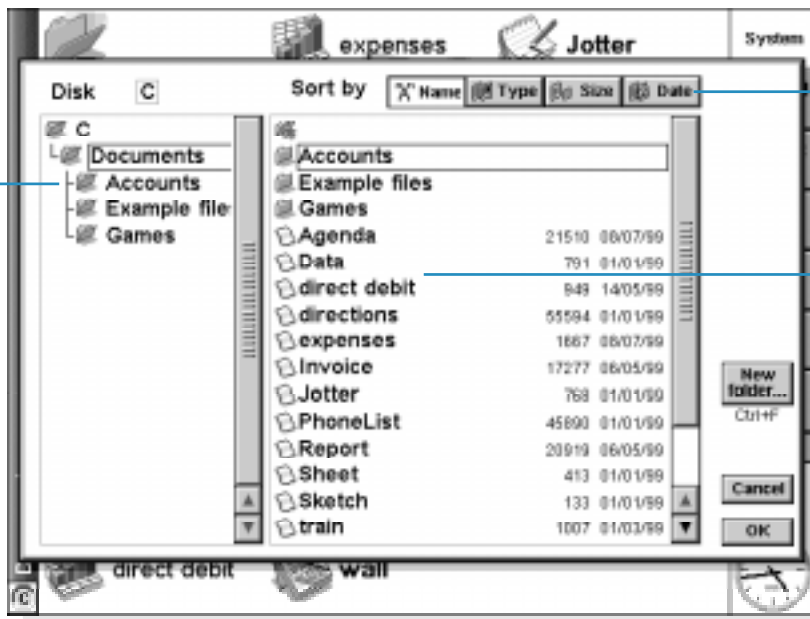

Using passwords

You can prevent other people from opening your Word and Sheet files by setting a password for each file. For example, you may have a Sheet spreadsheet containing your personal finance details. To set a password on a file:

1. Open the file and select the password command from the **File** menu.
2. Type your password twice for confirmation. Choose a password that you won't easily forget, but one that won't be easy for other people to guess.
3. Press the **OK** button, and the file is saved immediately with the password.

When you want to open the file, you will be asked to type in the password.



Important: don't forget your password!

If you have forgotten the password for a file then you will not be able to open it.

The password on an individual file will protect it if you transfer it to a Memory disk or another machine. If you copy the file, the copy will be protected by the same password. The password also prevents the file being converted to another format and read on a PC.

Changing file attributes

You can prevent a file from being accidentally changed by making it a “read-only” file. To do this, highlight the file in the System screen and select **Properties** from the **File** menu. Then tick the **Read-only** box.

Files that have been created on a PC and then transferred to the Series 7 may also be “read-only” files.

To check whether a file is a “read-only” file, highlight it in the System screen and select **Properties** from the **File** menu.

Note: If you transfer a “read-only” file to another machine, it can be viewed, and the “read-only” attribute can be removed.

Managing folders

To move one or more folders or files from one location to another:

1. First highlight the file(s) or folder(s) to select them. To highlight a consecutive list of files or folders, highlight the first one, hold down the Shift key, and then highlight the last one. To select items that are not consecutive, hold down the Ctrl key and tap each file/folder in turn.
To select all the files/folders in the current folder, use the **Select all** command on the **Edit** menu. To deselect items, press the Esc key.
2. Select the **Cut (move)** command from the **Edit** menu. A dotted line appears round the file/folder icon(s).
3. Go to the disk drive and open the folder into which the highlighted items are to be moved.
4. Select the **Paste** command from the **Edit** menu.

Note: Moving a folder also moves all the files within that folder.

Note: If you move (or rename) your most recently opened Agenda or Data file, you should open it again by selecting it from the System screen, rather than tapping the Agenda or Data program icon. Tapping on the program icon will create a new Agenda or Data file.

- **To copy a file or folder, or multiple files/folders to a different folder:** follow the earlier instructions, but select the **Copy** as opposed to the **Cut (move)** command from the **Edit** menu.
- **To make a copy of a file or folder within the same folder:** highlight it on the System screen and select the **Copy** command followed by the **Paste** command. A new file is automatically created for you using the following naming convention (with Word as the example): Word(01), Word(02), etc. You can rename the file or folder later if you wish.
- **To copy the entire contents of a disk to a folder on another disk:** e.g. to back up the entire contents of your Internal disk ('C') to a backup folder on a Memory disk ('D'), select **Copy disk** from the **Disk** menu.
- **To rename a single file or folder:** highlight it, select **Rename** from the **File** menu, and then type in a new name.
- **To rename a disk:** select **Name disk** from the **Disk** menu.
- **To remove one or more files or folders:** first highlight them and then either press the Del key, or select the **Delete** command from the **File** menu.

Important: If you are deleting folders, remember that the entire contents of the folders (including all the other folders contained within them and all their files) will also be deleted.

Checking memory use

- **To display the amount of memory remaining:** select **Show disk gauge** from the **View** menu to see the amount of free memory in the System screen Title bar. Tap on this gauge, or select the **Disk** command from the **Information** menu to see more detailed information about a selected disk.
- **To see information about total memory usage:** select the **Memory** command from the **Information** menu.

Which files use the most memory?

Certain types of files use more memory than others.

Sound files can become very large, so you should take care to delete unwanted Record and Voice note files so that they do not use up space on the Internal disk.

When recording a sound, the Series 7 will allow you to continue recording until the 'Time available' runs out. Even if the Time available is zero, the Record program will always leave approximately 100 kilobytes of free memory.

If you find that the amount of free memory is suddenly reduced, it is a good idea to check the size of any Record files.

Agenda files can also become very large. You should tidy your Agenda periodically in order to remove entries; see the 'Agenda' chapter for more details.



What will happen when the memory is full?

When the memory is nearly full, you will see warning dialogs when running programs to indicate that the Series 7's memory is almost full, and there is not enough memory to perform some tasks.

Many of the things you do need just a little free memory in order to work - displaying dialogs, menus, etc. These can fail with a message like 'Memory full'. Don't worry though, the Series 7 will not allow you to use all of the available memory; it will always set aside enough memory for you to close a program or save an open file to a Memory disk.

Files saved on the Internal disk and "open" programs both use memory. So, if the memory is nearly full you should be able to free some memory by closing some programs. You can use the **List open files** command from the **File** menu in the System screen to check which programs are running, and then close the programs or files that you do not need to have open.

You can also delete any unwanted files from the System screen, or move files to a Memory disk or your PC to free more memory.

Additional disks & programs

You can insert Memory disks into the tray on the left hand side of the Series 7. You might use them as additional memory for storing files, or to add more programs to the Series 7.

- **If a Memory disk contains additional programs:** their icons will automatically appear in the Extras bar when you insert the disk. They will be removed from the Extras bar when you take out the disk.
- **To delete all the files on a Memory disk:** put it in the slot, and then select the **Format disk** command from the **Disk** menu; select 'D' as the 'Disk' in the **Format disk** dialog. **Do not format the 'C' disk** - this will remove all the files you have stored on the Series 7's Internal disk, and remove all the preferences and settings that you have set up.

There are four additional Apps icons at the edge of the screen. Any programs appearing in the Extras bar can be allocated one of these icons so that they can be launched with one tap of the pen. To do this, tap the **Extras** icon on the Toolbar then tap the word 'Extras' on the title bar and select the appropriate program for each of the User Application entries.

Programs which have been allocated an icon no longer appear on the Extras bar. You can check which program has been allocated to an icon by holding down the Ctrl key while tapping the icon. The Program name will be displayed.

If you wish to run a translated OPL program, locate the file in the System screen, highlight the filename and tap it or press Enter to run it.



Can I run Series 3/3a/3c/3mx/5/5mx programs on a Series 7?

There are no major differences between OPL for Series 3/5 machines and OPL for the Series 7. If you have written programs in OPL on a Series 3/5, you should be able to translate them so that you can run them on a Series 7. Series 3/3a/3c/3mx **applications** (which are not written as OPL programs) **will not run on a Series 7**, however, applications written for Series 5/5mx should work but may not scale to cover the full screen size.



WORD

Word is the word processing program. It has many of the editing and formatting features that you would expect from a fully-featured word processor.

Many types of text formatting, e.g. alignment and font settings, can be applied to individual paragraphs or defined as a paragraph “style”.

Entering text

The text you type always appears at the current cursor location (there is a  marker in the margin to help you find the cursor). All text after the current cursor position moves to make way for the new text. To delete characters, press Del to delete backwards or hold down Shift and press Del to delete forwards from the cursor.

Top toolbar

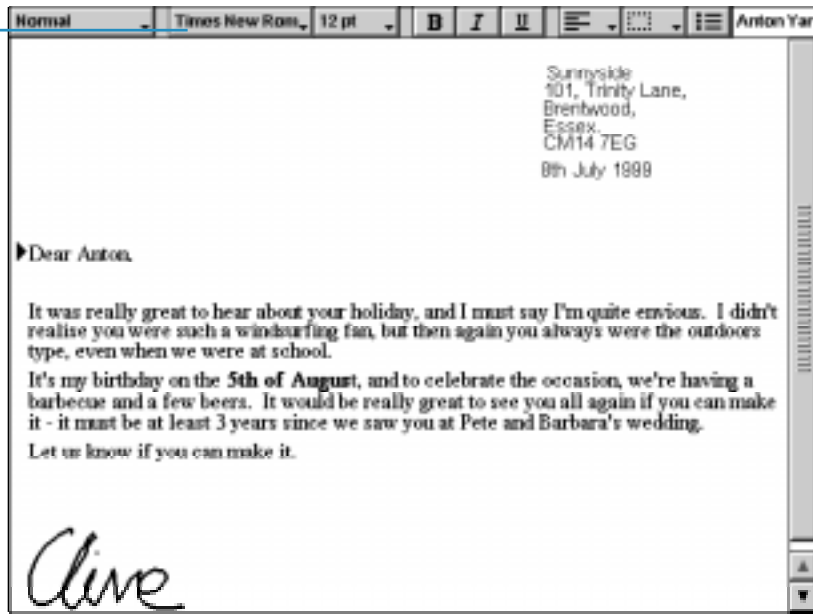

When text reaches the right-hand side of the screen, it automatically “wraps” the text onto the next line. If you want to view your page as it will be printed (“WYSIWYG”), switch off word-wrapping by removing the tick from the command on the **View** menu.

As you might expect, you can apply many commands to sections of text by highlighting them first. To highlight text, drag the pen over it or hold down Shift and use the arrow keys. To select all text in the file, use the command on the **Edit** menu.

- **To remove text:** highlight the text and press Del or select the **Cut** command. If you accidentally delete a section of text, you can replace it by selecting the **Undo delete** command from the **Edit** menu.
- **To copy text without deleting the original:** highlight it and select the **Copy** command from the **Edit** menu. To insert copied text, place the cursor where you want the text to appear and select the **Paste** command from the **Edit** menu.
- **To move a section of text:** highlight it and select the **Cut** command from the **Edit** menu. Place the cursor where you want the text to appear, then select the **Paste** command.
- You can make the text appear larger or smaller on the screen by selecting the **Zoom in** and **Zoom out** commands from the **View** menu. You can also select the **Set zoom** command to set a “custom” zoom level. Note that zooming does not affect printing.





Finding & replacing text

You can search through an entire file for a particular word or phrase and, if you wish, replace it with a different one. The **Find** commands are on the **Edit** menu or can be accessed from the **Find** button on the Toolbar.

- **To find text:** select the **Find** command and type in the text that you want to find. You can search “down” or “up” through a file - down searches from the current position to the end of the file, and up searches backwards to the beginning of the file. While searching, you can match the whole word, or make the search case sensitive.
- **To find and then replace text:** select the **Replace** command. Type the text that you want to find, as before, and the text that you want to replace it with. You can replace a single occurrence of the chosen text, or all occurrences from this point onwards.

Changing the appearance of text

You can highlight text then apply formatting to it, or select a format to use and then start typing:

- Press the  button for bold text,  for italics or  for underlined text (or use the commands on the **Text** menu).
- Press the button again, or remove the tick from the menu command to remove the effect, or switch it off.
- Use the button on the Top toolbar (e.g. ) to choose from a list of available fonts. Note that the text that appears on the button will reflect the current font. Use the size button (e.g. ) to change the size of text.

You can apply any of these effects, and also set the text position (e.g. for superscript and subscript text), use strikethrough text (crossed out), and change the text colour using the **Font** command on the **Text** menu.





Formatting paragraphs

Many formatting and spacing options can be applied to whole paragraphs. A paragraph may be a single word or title, a standard paragraph of text, or several lines grouped together, e.g. an address.

Each time you press the Enter key you start a new paragraph.

To start a new line without starting a new paragraph (e.g. for an address), hold down Shift and press Enter to insert a “forced line break”.

- To apply formatting to an entire paragraph, e.g. to change the horizontal alignment, place the cursor within the text of the paragraph using the pen or arrow keys, then tap the button or select the menu option. To apply formatting to a number of paragraphs, make sure that the highlight covers at least part of each paragraph. You don't need to highlight **all** the text in the paragraphs you want to format.

Aligning paragraphs

Alignment changes the horizontal position of paragraphs on the page. You may wish to align the text left or right with the appropriate margin, centre a title, or justify text to align both edges with the margins.

- To change the alignment: select the paragraph(s) to align, then tap  or select the command from the **Paragraph** menu, then select the alignment you want.

Note: Margins are set as part of the file's page setup. See 'How the page looks' later for more information.

Indents & tabs

Indents set the position of a paragraph between the margins, while tabs allow you to line up text on the page.

You can set left, right and first line indents for selected paragraphs by selecting the command from the **Paragraph** menu and entering a measurement (measured from the existing margins) in the boxes. The left indent applies to all lines except the first line, so that you can create a “hanging indent” by applying different left and first line settings.

You can change the standard tab setting, and set up custom tab stops for individual paragraphs by selecting the command from the **Paragraph** menu.

Bullets & symbols

To emphasise paragraphs that are items on a list you can precede each paragraph with a bullet.

- To add a bullet to a paragraph, tap  or select the command from the **Paragraph** menu. Use the menu command to change the bullet format, i.e. the size or colour of the bullet character, or the character to use.

Special characters

You can insert foreign and other special characters in your file by selecting the **Special character** command from the **Insert** menu.

You can also insert non-printing characters which control word wrapping on the screen and in the printed document:

- For a non-breaking space, press Shift and the Spacebar. This will prevent a line breaking at the space.
- For a non-breaking hyphen or “hard hyphen”, press Ctrl with the - key. This will prevent a line breaking at the hyphen.

You can use the **View preferences** command on the **Tools** menu to select which non-printing characters are displayed on screen.

Line spacing

When you select a particular font size, Word automatically uses an appropriate line spacing to make sure that there will always be a gap between successive lines of text. You might sometimes wish to override these settings, e.g. in a paragraph with different sizes of text.

- **To set line spacing:** select the command from the **Paragraph** menu and enter a point size. Set the spacing to ‘At least’ to ensure that lines of text never overlap, but will move further apart to accommodate any larger text appearing on the same line, or ‘Exactly’ to ensure that lines of text are always the same distance apart, even if larger text appears on the same line.
- To insert extra blank space between paragraphs, enter point sizes for the ‘Space above’ and ‘Space below’.

Note: The other lines in this paragraph affect where page breaks occur when the file is printed. See ‘How the page looks’ later.

Paragraph borders

You can draw a border around a paragraph. You can also change the background colour of a paragraph.

- **To draw a border:** select the paragraph(s) then tap  and select from the range of options. Or, use the command on the **Paragraph** menu to apply the borders and set the style and colour for each “side” of the border (i.e. Left, Right, Top or Bottom) and how far you want the border to be from the text. You can also set a background colour.
- Remember to set different background and text colours, otherwise the text will be invisible.



Using styles

A style is a collection of formatting options which can be applied to a whole paragraph using a single command or keypress.

Word has four built-in styles; Normal, Heading 1, Heading 2 and Heading 3.

- **To apply a built-in style:** select the paragraph(s), then tap the  button on the Top toolbar and select the style you want, e.g. Heading 1. You can also select the **Style gallery** command from the **Paragraph** menu.

Note: The text on this button changes to display the style of the current paragraph.

Style button

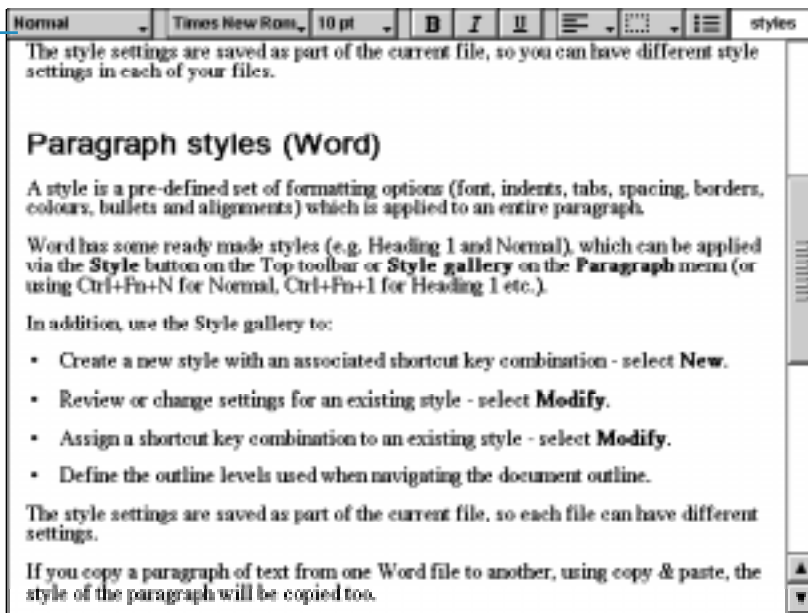

The style settings are saved as part of the current file, so you can have different style settings in each of your files.

Paragraph styles (Word)

A style is a pre-defined set of formatting options (font, indents, tabs, spacing, borders, colours, bullets and alignments) which is applied to an entire paragraph.

Word has some ready made styles (e.g. Heading 1 and Normal), which can be applied via the **Style** button on the Top toolbar or **Style gallery** on the **Paragraph** menu (or using Ctrl+Fn+N for Normal, Ctrl+Fn+1 for Heading 1 etc.).

In addition, use the Style gallery to:

- Create a new style with an associated shortcut key combination - select **New**.
- Review or change settings for an existing style - select **Modify**.
- Assign a shortcut key combination to an existing style - select **Modify**.
- Define the outline levels used when navigating the document outline.

The style settings are saved as part of the current file, so each file can have different settings.

If you copy a paragraph of text from one Word file to another, using copy & paste, the style of the paragraph will be copied too.

Defining styles

In addition to the built-in styles, you can create your own - either from scratch or by modifying an existing one. Styles are saved with the file, so each Word file can have different style settings.

1. Tap the **Style gallery** button on the Toolbar or select the command from the **Paragraph** menu and select **New** to create your own style, or select **Modify** to change the currently selected style in the list.
2. Press the **Format** button, then modify text and paragraph options as you wish.

If you are creating a new style, you can then name and assign an outline level and shortcut key. Your new style will now appear in the list of paragraph styles for the current file.

To delete a style you have created; tap the **Style gallery** button on the Toolbar or select the command from the **Paragraph** menu, select the style name from the list, and press Delete.

- You cannot delete or rename Word's built-in styles, but you can modify their settings for the current file. The built-in styles in other files will not be affected.

Document outlines

You can view an outline of a document, with one line for each paragraph style which has an “outline level”. The standard Heading styles use a sequence of different outline levels: Heading 1 is the highest with outline level 1, Heading 2 has outline level 2 and so on.

You can choose which paragraph styles you want to display in the outline, making it easier for you to see the structure of the document and move between different sections.

Select **Outline** on the **View** menu to see the document structure in outline. You can then:

- expand the outline to include other styles with a lower outline level. Highlight a particular line and tap again or press the right arrow to expand the level. Tap **Open all** to show all of the outline levels. Styles which have an outline level of zero are not shown.
- close the outline to show only the higher outline levels. Highlight a line and tap again or press the left arrow to close one level. Tap **Close all** to only show the highest outline level.
- tap **Done** or press Esc to return to the document.

You can change the outline level for any style so that you can display a document structure including your own headings or other styles. See ‘Using styles’ earlier for more about creating styles.





Moving around the document outline

You can use the document outline to move quickly to other parts of the document. To do this:

1. Select **Outline** on the **View** menu to display the document structure in outline.
2. Move the cursor to the line representing the section of the document that you want to move to (using the arrow keys to display or hide other levels as necessary).
3. Tap **Go to** or press Enter to return to the document with the cursor at this section in the text.

Document outline levels

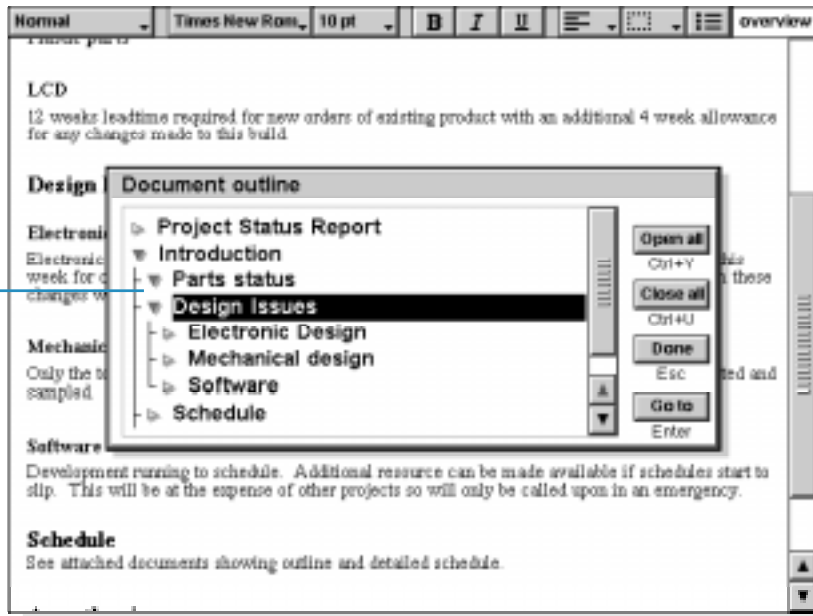

Information from other programs

You can add pictures, graphs, spreadsheets and sounds to your Word files by inserting information created by the other Series 7 programs. When a piece of information is inserted, it is known as an “object”.

Inserting an “object”

- **To insert a sketch:** tap the **Insert Sketch** button in the Toolbar or select the command from the **Insert** menu. A copy of the Sketch program will open where you can create your picture.

- **To insert a table or graph:** tap the **Insert Graph** button in the Toolbar or select the command from the **Insert** menu. A copy of the Sheet program will open. Word displays the inserted Sheet object as a graph or a spreadsheet, depending on the view displayed when you close the copy of Sheet.
- **To insert a sound or other object:** select the **Other object** command, and select from the programs which support this feature, e.g. Record for a sound recording. Close the program using the **Done** button at the top of the screen to return to Word.

Graph inserted from Sheet

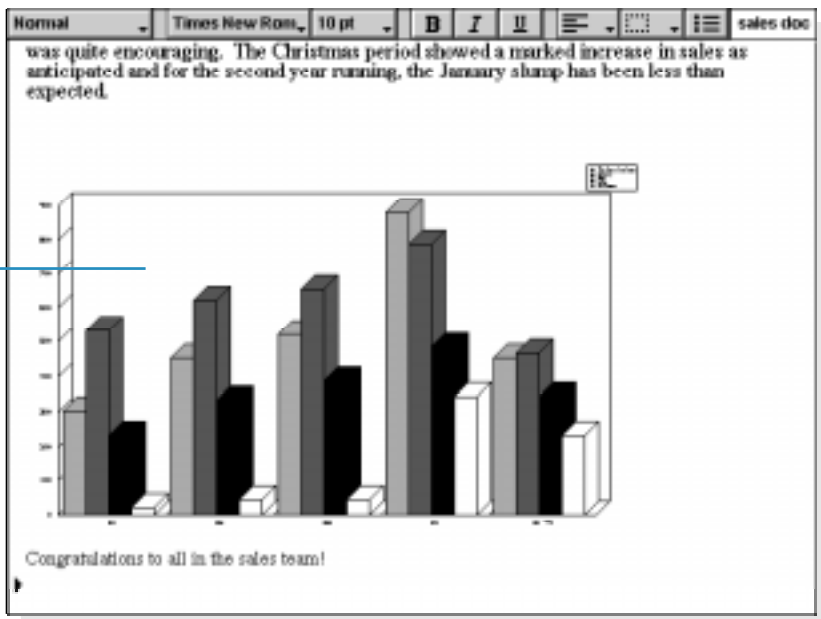



When you have inserted a sketch, table or graph you can select it, then use the pen to drag one of the “handles” to resize it. You can tap an object to edit it again. You can also format an object to resize it, or crop the edges to control the amount of the object displayed, by highlighting it and using the **Object** commands on the **Edit** menu.

You can also use the **Format object** command to display an object as an icon of the program that created it to save space on screen. To set a preference so that objects are always displayed as icons when first created, use **Object preferences** on the **Tools** menu.

Some objects, e.g. sounds from Record, are always displayed as icons and cannot be formatted. Tapping the icon (or selecting it and pressing Enter) opens a copy of Record so that you can play the sound.

Important: Note that inserting objects into a file causes a considerable increase in file size.

Spell checking

To check the spelling of a Word file, tap the **Spell** button on the Toolbar or select the command from the **Tools** menu (to check the spelling of a single word or phrase, highlight it first). Spell will display any words that are not found in the Spell dictionary, or included in the Personal dictionary (if applicable). You can then:

- correct the unrecognised word. Type in the correct spelling, or choose from the list of suggested alternatives.

- ignore the word and leave it unchanged in the Word file, or ignore all instances of the word in the file.

- add the word to Spell’s Personal dictionary.

See the ‘Spell’ chapter for more about spell checking.

Creating a new file

To create a new Word file, use the **Create new file** command on the **File** menu in Word or the System screen. If you do this in the Word program you can enter a filename and location and select a “template” for the new file.

File templates

A template is a document design that you can use as a starting point for new documents. The template can include text, paragraph styles and page layout information. When you create a new document using a template, Word copies the information in the template into the new file which you can then change as you require. For example, you can use the standard Fax template to create a fax - the template includes the coversheet text and you can add the fax details and number.

You can select from a number of standard templates. When you open a document using a particular template, you then work on a document based on the template; you don’t change the template itself.

Creating a template

If you can’t find a suitable built-in template, you can create your own file template. To do this:

1. Create the Word file with the text, styles, page layout, headers, footers, and so on that you want to include in the template. Note that other settings such as the cursor position and printer setup are also stored.

If you want to change an existing template, open a new document using the template and make the changes to this Word file.

2. Select **Save as template** from the **More** commands on the **File** menu.
3. Enter a name for the template. If you are making changes to an existing template, type the original template's name. Word displays templates with (C) or (D) added to the name, according to the disk you use to store the file.

You cannot change the standard built-in templates in Word, although you can use them as a starting point for your own customised templates.

You can use the **Delete template** command (from the **More** commands on the **File** menu) to delete a template you've created. You cannot delete the built-in templates.



Setting the "default" template.

If you create a new Word document from the System screen, Word uses the built-in 'Blank document' template. If you want to start documents in the System screen using a different template, create a template as before but type the name "Normal" for the file. Word will use the 'Normal' template if it exists, otherwise it will use the blank template.

Document template

The screenshot shows a Word document template titled "Fax" with a ribbon at the top. The ribbon includes "Fax heading", "Arial", "10 pt", and icons for Bold (B), Italic (I), Underline (U), Bullets, Paragraph, and a "purchase" button. The main content area features the word "Fax" in a large font, followed by a form with the following fields:

To:	From:
Fax:	Fax:
Phone:	Date:
Re:	No. pages:
CC:	

Below the form, there are four checkboxes, each with a checkmark: "Urgent", "For review", "Please reply", and "Please comment".





Saving Word files

When you edit a Word file you are actually working on a copy of the file stored in memory. When you close Word this file is automatically saved to disk. If you do not specify a filename it will be called Word, and subsequent files will be saved as Word(01), Word(02), and so on. To save a file using a different name, or in a different folder, select the **Save as** command from the **More** commands on the **File** menu.

To create a new Word file, use the command on the **File** menu and enter a filename and folder. The current file is closed and automatically saved.

You can undo all changes since the last “save” using the **Revert to saved** command on the **File** menu. This will re-open the most recently saved version of the file.

Note: If you password-protect a file, it is immediately saved as “password-protected”. If you revert to saved, you will need to enter the password for the file.

How the page looks

When you create a new file, Word uses standard page settings to control how your text will appear when printed. To change the page setup for the current document, select the **Page setup** command from the **Printing** commands on the **File** menu; adjust the paper size, orientation and margins as appropriate.

Page breaks

Word automatically fits text to the paper size and continues on to another page where necessary. If you want to have more control over where new pages start, you can insert your own page breaks and set page breaking options for individual paragraphs.

- To start a new page, place the cursor at the desired point and select the **Page break** command from the **Insert** menu, or hold down Ctrl and press Enter.

To define how Word prints a specific paragraph, place the cursor in the relevant paragraph, or highlight several paragraphs, then select the **Line spacing** command from the **Paragraph** menu. You can select from the following:

- ‘Keep together’ to prevent a page break within the paragraph.
- ‘Keep with next’ to ensure that a paragraph always appears on the same page as the paragraph that follows it.
- ‘Start new page’ to ensure that a paragraph will always appear at the top of a new page.
- ‘Allow as widow/orphan’ to let a single line at the beginning or end of the paragraph appear on a separate page from the remainder of the paragraph.

You can display where page breaks will occur in a file by selecting the **Paginate** command from the **Tools** menu. The position of each page break is then shown with a dotted line. Note that the dotted lines are not automatically updated if you edit the document further, so you will need to select the **Paginate** command again if you wish to repaginate and update the position of the dotted lines.

Headers, footers & page numbers

Headers and footers are pieces of text (e.g. page numbers or a chapter title) which appear at the top and bottom of each page of a printed file. To add a header or footer, select the **Page setup** command from the **Printing** commands on the **File** menu, and select the Header or Footer page in the dialog. Enter your text in the box and format it as desired.

To insert page numbers, the current time or date, or the file name, press the **Insert** button and select from the options available. Word automatically updates page numbering as you edit your file.

Printing

If you have a printer ready for use with the Series 7, you can print your Word files. You can preview how your printed file will appear on paper and review all your page setup options beforehand.

- To preview your printed document, tap the **Print** button on the Toolbar or select the command from the **Printing** commands on the **File** menu. Word paginates your file and displays the first page(s) on screen. You can use the **Setup** options to control the number of pages displayed in the preview and whether or not visible margin lines are shown.
- To print the file, select the command from the **Printing** commands on the **File** menu. You can choose to print the entire file, or only a selection of pages. You can also print multiple copies of the file.

See the 'Printing' chapter for more details.

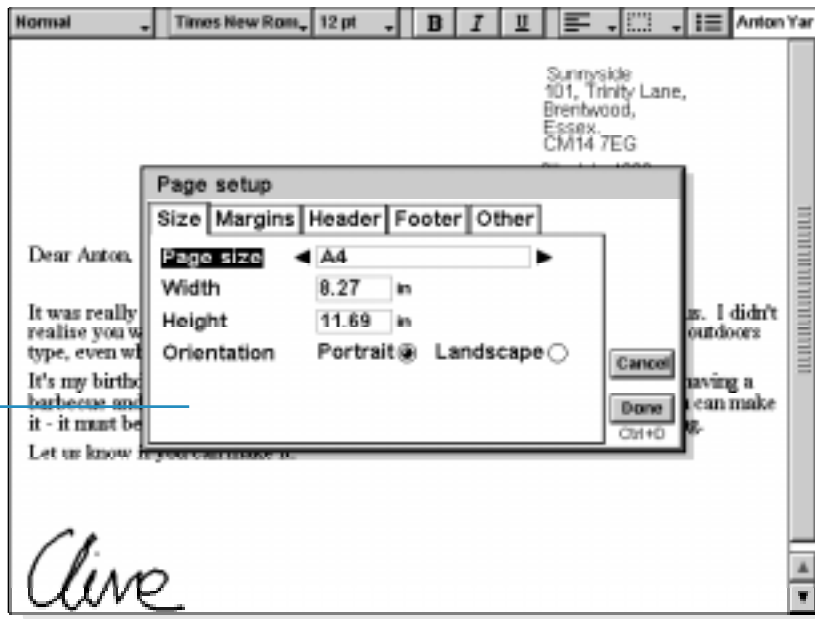

Page setup





SHEET

Sheet is the spreadsheet program. It has many of the features and functions that you would expect from a fully-featured spreadsheet.

You can use Sheet to create worksheets, and use PsiWin to transfer worksheets to and from your PC.

Sheet has two views:

- The Sheet view, where information is displayed in cells on a worksheet. Cells are referred to by their position in the grid of columns and rows, e.g. D3. You can present information in table form in Sheet, and perform calculations based on sets of numbers stored in the worksheet.
- The Graph view, where you can create graphs based on information stored in the worksheet.

Univers		10 pt	B	I	U				Σ	/%	Fuel usage
C3		=SUM(\$C\$5:\$C\$47)									
	A	B	C	D	E	F	G	H	I		
1	Fuel usage	Totals:			Averages:					Prefer	
2		480	68.65	£41.91	£0.6105	32.448	11.484	8.707	Travel		
3									Fuel p		
4	Date	Miles	Litres	Cost	Litre price	MPG	Km/l	/100km	Fuel e		
5	Start miles	29021									
6	02/03/98	29102	11.34	£6.81	£0.608	32.471	11.483	8.701	Varial		
7	15/03/98	29332	32.31	£20.00	£0.619	32.361	11.454	8.731	Name:		
8	22/03/98	29511	25.00	£15.00	£0.608	32.549	11.520	8.680	Name:		
9									Name:		
10									Const		
11									Kilome		
12									Litres		
13									Litres		
14											
15											
16											
17											
18											
19											
20											
21											
22											
23											

Column heading

Top toolbar

Row heading

Moving around

The current cell is indicated by a dark border around a cell. The information you enter in the input line applies to this cell.

- Tap any cell to select it, or use the arrow keys to move around. You can use the scrollbars or the arrow keys to move to other areas of the worksheet. Hold down the Ctrl key and use the arrow keys to move by a whole screen at a time.
- Use the **Find** commands on the **Edit** menu to move to other cells. Use **Find** and **Find next** to move to cells if you know their content, or **Go to** to jump to a specific cell.

Note: You can alter the number of cells displayed by using the zoom commands, or by setting the zoom level using the command on the **View** menu.

Highlight more than one cell to perform actions which apply to an area:

- **To highlight more than one cell:** drag the pen from the first cell in the block to cover the desired cells, or hold down Shift and use the arrow keys.
- **To highlight a whole column or a whole row:** tap the shaded column or row heading, e.g. “C” or “2”.
- **To highlight the entire worksheet:** tap the square in the top left corner of the worksheet headings.

Entering information

To enter information in a cell, select it and start typing. You will see the information you are entering on the input line. The first character you type tells Sheet what kind of information the cell will contain:

- **To enter numbers:** begin with a number or with one of these characters: . - + and (.
- **To enter text:** simply type it in. If your text starts with a number, type a ' first, e.g. '24 Longton Road. If you want the text itself to contain a ' at the beginning, type two of them, e.g. '97 sales figures.
- **To enter a formula for a calculation:** begin with a =. For example, to make a given cell display the sum of the contents of cells B1 and B2, type in =B1 + B2.
- **To edit the information in a cell:** simply highlight the cell and press Enter. You can then edit the contents on the input line.
- **To enter a date:** type the day, month and year on the input line, separating them with a space or the date separator character as set in the System screen, e.g. 1 Oct 69 or 1 10 69, or 10 1 69 if you use this date format.
- **To enter a time:** type the hour, minutes and seconds, separating them with a colon (or the time separator character as set in the System screen).





You can also change the width of columns and the height of rows, to suit the information contained in them. To do this:

- Drag the right-hand edge of the column heading to adjust its width, and the lower edge of the row heading to adjust its height.
- Use the commands on the **Format** menu to set the height of a row in points and the width of a column in characters.

Note: If you enter more text than can be displayed in the current cell, the information will run over into the next column if that column is empty, so you may want to adjust the column width. If you enter a number that's too long for the cell, you will see a series of # signs in the cell, though the actual number will still be stored.

- **To freeze panes on the worksheet:** type the information you wish to “freeze” in the rows and columns, position the pointer in the cell below the row to freeze, and to the right of the column to freeze (this will often be B2). Tap the  button, or select the command from the **View** menu. The “frozen” panes will stay on screen when scrolling through the rest of the worksheet.
- **To protect the worksheet from changes:** select the **Protection** command from the **Tools** menu.
- **To allow changes to some cells only:** highlight the area you for which you wish to allow changes, select the **Protection** command on the **Tools** menu and remove the tick to “unlock” the highlighted cells. If you then protect the worksheet, changes are only allowed to the cells that are not locked.

Performing calculations

There are two ways to perform calculations:

- Type the calculation into a single cell. When you press Enter or move to another cell, the result will be displayed on the worksheet.
- Use a formula for a calculation; just type the different parts of your calculation in separate cells and note their references, e.g. income in B2 and tax in C2. In a new cell, enter the formula, beginning with a =. Use the cell references for the components of the calculation rather than the numbers themselves. For example, =C2-(B2*C2). The value displayed in this cell is calculated for whatever values you use in the component cells.

Note: If you have a row or column of cells and want to know their sum, position the pointer in the cell at the end of the row or column and tap the  button. Sheet will insert the formula for the sum of the preceding group of cells and calculate the result.

There are two types of cell reference you can use in a formula:

- Relative references, such as A2. These get updated when copied and moved elsewhere. For example, a reference to cell A2 in a formula in cell B3 will change to B2 if the formula is copied to cell C3.
- Absolute references, such as \$A\$2. These contain a \$ sign in front of the parts of the reference that you don't want to change even if the formula is moved elsewhere. So, \$A\$2 in cell B3 remains \$A\$2 when copied to cell C3.

- You can combine the two types of reference: A\$5 in A6 will become B\$5 when copied to B8.

A formula which contains a reference to its own cell, either directly or indirectly, is called a “circular reference”. You can find any circular references in the worksheet using the **Find** commands on the **Edit** menu. You should avoid making circular references as they produce unpredictable results.

Use = to enter formulae

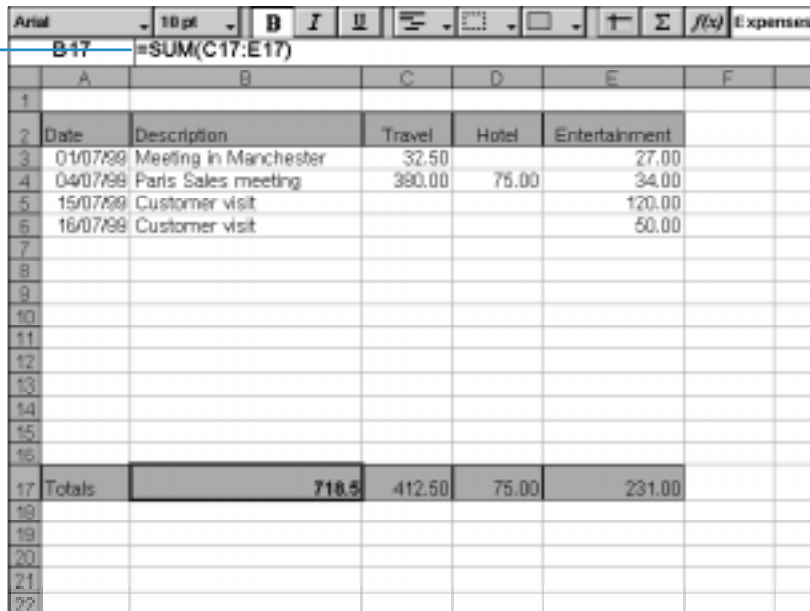

The screenshot shows a spreadsheet with a table of expenses. The formula bar at the top shows the formula =SUM(C17:E17) in cell B17. The table has columns for Date, Description, Travel, Hotel, and Entertainment. The totals row shows a total of 718.5 for the Description column, 412.50 for Travel, 75.00 for Hotel, and 231.00 for Entertainment.

	A	B	C	D	E	F
1						
2	Date	Description	Travel	Hotel	Entertainment	
3	01/07/99	Meeting in Manchester	32.50		27.00	
4	04/07/99	Paris Sales meeting	390.00	75.00	34.00	
5	15/07/99	Customer visit			120.00	
6	16/07/99	Customer visit			50.00	
7						
8						
9						
10						
11						
12						
13						
14						
15						
16						
17	Totals	718.5	412.50	75.00	231.00	
18						
19						
20						
21						
22						





Recalculation

Sheet automatically recalculates your worksheet every time you change part of a calculation. You may want to turn this feature off if you are making a large number of changes in the worksheet. To do this:

- Tap the **View Prefs** button on the Toolbar or select the **Preferences** command from the **Tools** menu, and set Auto recalculation to off. When Auto recalculation is off, a '+?-' symbol will be displayed at the right end of the input line whenever you need to recalculate manually to update results.

To make Sheet recalculate the worksheet, select the command from the **Tools** menu.

Functions

Sheet has a large number of functions, e.g. mathematical, financial and trigonometric functions, that you can incorporate in your calculations. See the built-in help on the Series 7 for a full list and details of syntax.

- **To use a function in a calculation:** just type it in. Alternatively, tap the function button or select **Function** from the **Insert** menu. Choose the function you require.

Using ranges

A range is a rectangular block of cells. The reference for a range consists of the cell references of the top left and bottom right corners of the block, separated by a colon, e.g. B2:C6. You can use ranges to define areas of the worksheet for applying formatting, creating graphs, or include range references in formulae, e.g. =SUM(B2:C6).





- **To select a range:** highlight all the cells you want to be a part of your range.
- **To use a range in a formula:** highlight the range to be inserted while entering the formula. For example, type "=SUM(" then drag the highlight to cover the appropriate range, type a ")" and press Enter.

Naming ranges

- **To name a range:** highlight the range and add a name using the **Add name** command from the **Name** commands on the **Insert** menu. You can use this name in sums and formulae, e.g. "=AVERAGE(Bills)". You can edit the range name using the **Edit name** command.

Changing how information is displayed

You can format the information in the worksheet in a number of ways, e.g. to differentiate the parts of tables and calculations. Formatting is applied to the currently selected cells.

- **To change the alignment of information:** tap  to set the horizontal alignment, or use the command on the **Format** menu to set both the horizontal and the vertical alignment.
- **To change the font:** use the buttons in the Top toolbar to change the font or font size. Alternatively, use the command on the **Format** menu to select the font, font size and other attributes, e.g. bold, superscript, strikethrough etc.
- **To add bold, italic or underline:** use the  buttons, or use the **Font** command as described above.
- **To add a border:** tap  or select the command from the **Format** menu and select a border style for the each side of cell.
- **To add shading:** tap  or select the command on the **Format** menu, and select the shading you want to apply.

Sorting information

You can sort rows in a list based on values in a single column or in several columns. You can also sort columns based on values in rows, if your list is set up that way. In either case, you can sort using more than one row or column. For example, if you want to sort a table based on a 'surname' column, but have more than one entry for each surname, you can also sort again using a 'first name' column.

Sorting from top to bottom

You can sort information in order from highest to lowest value, or into alphabetical order, according to the information in a particular column. Use this type of sorting if you want to change the order of the rows in a table, e.g. to sort entries in a table into the order specified by an 'Amount' column.

To sort from top to bottom:

1. Highlight the range of information that you want to sort. Sheet will only sort information inside this range.
2. Tap the **Sort** button on the Toolbar and select **Top-to-bottom** or select the command from the **Tools** menu.
3. In the dialog, select the column that you want to use to order the rows, and specify the way that you want to sort. Click **Options** if you want to make the sort case sensitive.





Sorting from left to right

You can also sort from left to right. Use this type of sorting if you want to change the order of the columns in a table.

To sort from left to right:

1. Highlight the range of information that you want to sort, rows and columns. Sheet will only sort information inside this range.
2. Tap the **Sort** button on the Toolbar and select **Left-to-right** or select the command from the **Tools** menu.
3. In the dialog, select the row that you want to use to order the columns, and specify the way that you want to sort. Click **Options** if you want to make the sort case sensitive.

Changing the number format

Select the **Number** command from the **Format** menu to change the number format. You can set the formats for the current highlighted range or all cells in the worksheet.

The number formats include general, triad (e.g. 3 000 000) and scientific number display, as well as special formats for displaying text, currency, dates and times, percentages, and also for a format for hiding the contents of cells.

Note: Some settings for the way numbers are displayed, e.g. the thousands separator, are set in the System screen.

Arial 10 pt		B I U		Σ / (/x/)		formats	
D14	Top						
A	B	C	D	E	F	G	
1							
2	Formats						
3							
4	Sample time formats		number formats				
5	2/14		General	145			
6	02/14/99		Fixed	145.00			
7	14 Feb 99		Scientific	1.45E+02			
8	February 14, 1999		Currency	£145.00			
9	14/02/1999 12:00 am		Percent	17.50%			
10			Triad	0.18			
11							
12			Alignment				
13			Left	Centred	Right		
14			Top	Centred	Bottom		
15							
16							

Number formats

Graphs

You can use Sheet to create, format and print graphs based on information on the worksheet, for example to show annual sales figures, or the distribution of revenue.

You can create many types of graphs including line graphs, bar and column graphs, scatter charts and pie charts, and can add to or alter many aspects of the graph's appearance by tapping on the area of the graph you wish to change.

Creating a graph

To create a graph:

1. Highlight a column or row of numbers in the Sheet view. This will be the first “range” that your graph depicts. You can add other ranges later on to build up your graph.
2. Tap the **Graph** button on the Toolbar to move to the graph view. You will see your graph displayed on the screen.

Use the **Sheet** and **Graph** buttons on the Toolbar to switch between the two views.

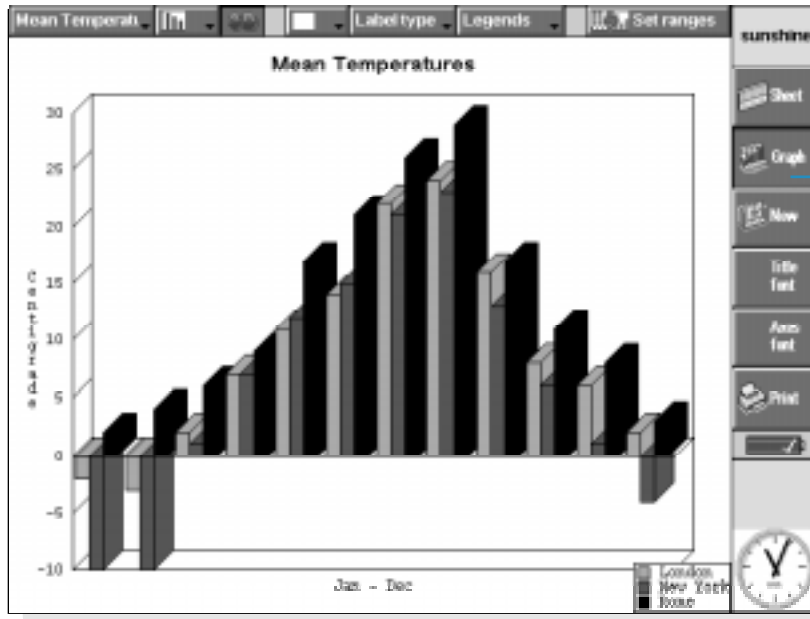

Graph view





Replacing the graph range

When you create a graph, it is set to the range you first specified. It will reflect changes to the data within that range, but will not reflect other ranges you highlight on the worksheet. To replace the current graph range (or ranges) with a new one:

1. In the Sheet view, highlight the new range you want the graph to use.
2. Switch to the Graph view, then press the **Set ranges** button. The new range(s) will replace the old one(s) as the subject of the graph.

Adding a range to a graph

You can add further ranges to graphs to display additional information, e.g. to include a previous year's sales figures as well as the current ones.

- **To add a range to a graph:** select the range you want to add to your graph in the Sheet view, switch to the Graph view and then select the command from the **Ranges** menu.

Graph type & appearance

When you first create a graph, it will be a column graph. Change the type using the  button, or the **Graph settings** command. The graphs types include line graphs, bar and column graphs, scatter graphs and pie charts.

- **To change the graph from 2D to 3D and back:** use the **3D** button on the Top toolbar, or the **Graph settings** command.
- **To change the pattern used for a range:** select the **Change range** command from the **Ranges** menu, then choose the range and the fill colours and styles for each range.
- **To change the background, text and line colours of a graph:** use the Colours and Styles pages in the Graph settings and Change range dialogs.

Note: You can alter many aspects of the graph appearance by tapping on the area of the graph you wish to change.

Adding titles, labels and grid lines

- **To add a title to a graph:** select the **Graph settings** command from the **Graphs** menu and insert the title. You can change the style and font of the title using the **Title font** command on the **Graphs** menu or by tapping on the **Title Font** button.
- **To add axis titles:** use the **Format X-axis** and **Format Y-axis** commands. You can also use these commands to format the X and Y axes, e.g. to add grid lines, tick marks, add or remove axis labels, alter the axis position and scale, or hide them completely.
- **To add labels to each range:** use the **Change range** command to specify the type of label you want and the cells in which your labels are stored.
- **To add a legend to a graph:** tap the **Legends** button and select the desired position for the legend. Alternatively, use the **Graph settings** command.

Working with more than one graph

You can create more than one graph for a worksheet and switch between them easily.

- **To create a new graph:** highlight the first range for the new graph, then switch to the Graph view. Select the **New graph** command from the **Graphs** menu, and specify the settings for the new graph.
- **To switch between the graphs you have created:** tap the **Graph** button on the Top toolbar or use the command on the **Graphs** menu.

Printing from Sheet

You can print a range of pages, the entire worksheet or a graph from Sheet using the **Printing** commands on the **File** menu. You need to set up the page layout and printer first, using the **Page setup** and **Print setup** commands. You can use the **Print preview** command or the **Print** button in the Toolbar to display a preview.

See the 'Printing' chapter for more details.





CONTACTS

You can use the Contacts program to store information about your “contacts”, such as those found in an address book. Each contact includes “labels” for details such as names, addresses, email addresses, telephone and fax numbers.

Adding a contact

You can add contact details in any order. To add a contact:

1. Tap the **New contact** button or select the command from the **File** menu.
2. Type the contact information next to the appropriate labels.
 - Tap on a label or use the arrow keys to move between the boxes. Use the scroll bar to see labels which are not currently displayed.
 - Tap on the page headings to move between the personal and work pages.
3. Tap the **Save** button when you've finished typing in the contact details.

Note: If there is no suitable label for the information you wish to enter, you can add a new label. See ‘Contact labels’ later.

Looking at your contacts

Contact details are displayed as a single page, with the contacts list shown alongside.

- To sort contacts alphabetically by first name, last name or company name, use the **Sort** button on the Toolbar or the command on the **View** menu.
- To adjust the width of the list and contact details, use **Preferences** on the **Tools** menu.



How do I dial a telephone number?

You can dial a contact's telephone number by selecting the contact and tapping the **Dial** button on the Toolbar. See the ‘Dialling’ chapter for details of how to dial numbers directly from Contacts and other programs.

Finding contacts

You can find contacts by typing part of the name, or search for text contained anywhere within the contact details.

- To search for a contact by name, simply type the first few letters of the name in the 'Find:' box and press Enter. Only the name and company name are searched.
- To search for text contained anywhere within a contact's details, e.g. text in an address, email or notes label, tap on the **Find in all text** button on the Toolbar or use the command on the **Edit** menu.



Search tips.

Type a ? for a single unknown letter or a * for any number of unknown letters (known as "wildcards"), e.g. typing '?ath' would find 'cath' and 'kath', whereas typing '*ath' would also find 'goliath'.

After a search, only those entries including the search text will be displayed. To display all the contact entries again, tap on the 'Find:' box.

List of contacts

Andrews, Kevin
Aylott, Paul
Balkowiec, Stefan
Barrett, Dave
Bayley, Stephen
Bellworthy, Nigel
Brown, Charlie
Brown, Kevin
Calcutt, Steve
Colquhoun, Charlie
Cox, Stella
Cox, Tony
Dempsey, Mark
Doulton, Daniel
Edwards, Bill
Griffiths, Hugh
Hope, Chris
Ian, Madden

Find: [] 8:42

First name: Kevin
Last name: Brown
Mobile: 0962 345254
Home tel: 01992 883223
Home address: 98, Trinity Lane
Waltham Cross,
Herts. EN8 7ET
Company: Acme Design Corp
Job title: Development director
Work tel: 01920 456092
Work fax: 01920 453768
Work email: kevin.brown@acme.com
Work address: 127, Hertford Road
Ware
Herts.
Notes: Wife Sandra, Children
James and Emma

Contacts
New contact
Find in all text
Edit contact
Add
Set
Print

Label

Details of selected contact





Editing & deleting contacts

To change a contact's details:

1. Select the contact you wish to edit, then tap on the **Edit contact** button on the Toolbar or select the command from the **File** menu.
2. Change the contact details as required, and tap the **Save** button to save your changes.

To delete a contact, select the command from the **File** menu.

Note: If you delete a contact accidentally, select **Undo delete** on the **Edit** menu to get it back again.

Contact labels

If the current contact labels are not suitable for the information you wish to enter, you can add, remove and rename the labels used by all new contacts. It is best to set up the labels you want before you start to type in your entries.

Note: If you wish to store different types of information, you can use the Data program to create a custom database. See the 'Data' chapter for more information on creating your own databases.

Changing labels

Each individual contact can have different labels to other contact entries. To add a label to a single contact:

1. Open a contact by adding a new contact or editing an existing entry.
2. Tap **Add item** and select the label to add to the contact.

Note: The label you select will only be added to this individual contact.

You can add, remove, rename and change the order of labels used for **all** new contacts. To do this, select **Set up labels** on the **Tools** menu.

- To add a new label, tap **Add item** and select a label type.
- To change the name of a label, select it and tap **Rename**.

- To change the order of a label in the list, select it and use **Move up** and **Move down**.
- To delete a label, select it and tap **Delete**.

Note: You can't delete labels from existing contacts, but you can prevent a label's title appearing by deleting its contents.

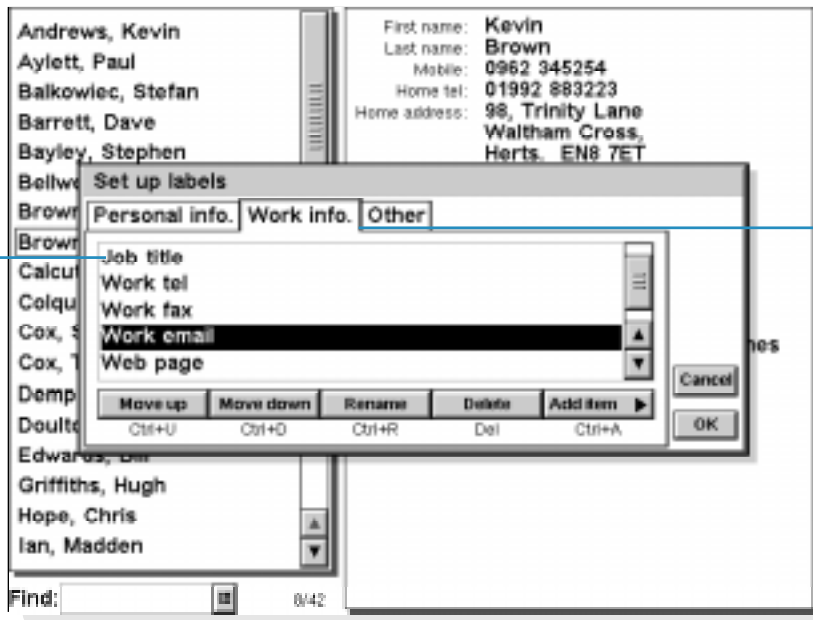

Label

Page label appears on





Exchanging contacts

You can exchange contact details with other programs and machines which support the 'vCard' standard. You can also exchange contacts using Infrared with other machines which support the 'vCard' and 'IrObex' standards (see 'Infrared' for more details).

To do this, use the **More** command on the **File** menu to:

- **import** information from a vCard file into Contacts.
- **export** contacts as a vCard file for use with another program.

Note: You can choose to export only the selected contact, or all contacts currently in view (e.g. the result of a search).

Printing contacts

You can print all your contacts, or choose a set of contacts to print by using a search.

- Before you print, refer to the instructions in the 'Printing' chapter to select a printer.

To print contacts:

1. Display the contacts you wish to print.

Note: If you do not wish to print all the contacts, select a contact or use the find commands to display a selection of contacts (see 'Finding contacts').

2. Tap on the **Print** button on the Toolbar or use the **Printing** commands on the **File** menu:
 - Use the **Page setup** command to control the page size, margins, and add headers and footers. See the 'Printing' chapter for more details.
 - Use the **Print setup** command to specify which contacts to print, and the number of copies.
 - Use the **Print preview** command to see how your printed copy will look.
 - Use the **Print** command to print your entries.

Search results

The screenshot shows a contact list window with a search bar at the bottom left containing the text "Find: po". The search results list contains two entries: "Poore, Noel" and "Pozzilli, Christine and Tony". The "Pozzilli, Christine and Tony" entry is selected, and its details are displayed on the right side of the window. A "Dial" dialog box is open in the foreground, showing the contact's mobile and home telephone numbers. The dialog box has four buttons: "Cancel" (Esc), "Free input..." (Tab), "Dial" (Space), and "Dial out" (Enter).

Poore, Noel	First name: Christine and Tony
Pozzilli, Christine and Tony	Last name: Pozzilli
	Mobile: 0962 353624
	Home tel: 0181 979 9876
	Home address: Merryweather Cottage School Lane Bushey Herts

Dial

Mobile: 0962353624

Home tel: 01819799876

Cancel (Esc) Free input... (Tab) Dial (Space) Dial out (Enter)

Find: po 2/2

Dial dialog

Search clue





AGENDA

You can use the Agenda program as a time manager, for recording appointments, events, birthdays, anniversaries and lists of things to do.

When you first open Agenda, you'll see a planner for the current week, or the "Week view". You can start adding your appointments and other entries straight away by moving to the appropriate day and typing them in.



What if I already use a PC scheduler?

If you already keep your schedule on your PC, you can use PsiWin to synchronize your PC scheduler with a new Agenda file to quickly bring all your PC entries across. You can then synchronize regularly to keep the information up to date in both places. See the PsiWin on-line help for more details.

To-do entry

Handwritten entry

Change view

Entry crossing midnight

September 1999

John B Birthday (10)

Holiday

Report deadline

Holiday

Far East trip

Holiday

445 Leave for airport (5:45pm)

800 Flight to HK (8:00am)

Flight to HK

Agenda

View

Switch

Word

Find

Today

Go to

Clock

Moving around

- Use the arrow keys to move around the days.
- Press the **Today** button on the Toolbar, or the Spacebar to go to today's date. Press the Spacebar again to move back to the day you were on.
- Tap on the **Goto** button on the Toolbar and enter the date that you want to go to. Tap OK.
- Tap on the “dog ears” in the bottom corners of the pages to move between pages.
- To move between dates, tap on the title of the view or press Ctrl+J to see a calendar (you can also press Tab in some views). Move the highlight to the date you want and press Enter.

Note: The Agenda has a number of other views, e.g. a Day view and a Year view. You can set preferences to change which view you see when you first open the Agenda program, and customise other aspects of the way Agenda works. See 'Customising Agenda' later.

Adding appointments & events

Agenda has 3 types of entries for appointments and events:

- **Timed day entries** for appointments that you wish to give a duration, e.g. a meeting or dental appointment. The duration can be displayed in the Agenda views so that you can see when you are busy. A timed entry can have any duration (up to 31 days).
- **Untimed day entries** for an appointment without a duration.
- **Events** for entries that you wish to last a specified number of days, which do not have start and end times, e.g. holidays.





Timed & untimed entries

To enter a “timed” or “untimed” day entry:

1. Move the cursor to the date of the appointment and start typing. As soon as you start typing the New entry dialog is shown where you can set the start time and duration of the appointment. If the appointment does not need a start time, remove the tick from the Timed entry box.
 - A timed entry appears with a start time, and can also be displayed with a duration. Entries which cross midnight are marked with « on subsequent days.
 - An untimed entry appears with a bullet and is displayed in the time slot where you type it in.
2. You can set the duration or end time of a timed entry in the New entry dialog, or tap the **Alarm/More** button and move to **Details** page to enter a duration longer than 23 hours.

Note: Each view has a standard entry type that is created when you start to type. To add other types of Agenda entry, select **Create new entry** from the **Entry** menu, and then select the type of entry you want. You can change the standard entry type for each view. See ‘Customising Agenda’ later.

Note: You can add a handwritten entry by writing the entry as a sketch; see ‘Attaching a sketch’ later.

Events

- **To enter an event:** select the command for creating a new event from the **Entry** menu. Type in the details of the event, e.g. ‘Holiday in Spain’ and set the start date and duration in days. Event entries are marked with a flag symbol ().

“Pencilling in” a tentative entry

- To pencil in an Agenda entry, e.g. to reserve a time slot for an appointment that has not been confirmed: press the **Alarm/More** button in the New entry dialog, move to the **Other** page and tick the tentative entry box. The entry will be displayed as grey text in the Agenda views.
- **To confirm a tentative entry:** highlight the tentative entry, then select the command from the **Entry** menu to remove the tick from the menu command.

Viewing entries

Agenda has the following views, for looking at Agenda entries in different ways:

- Day view - shows all the entries for one day, hour by hour.
- Week view - shows the entries for the whole week.
- Anniversary view - shows birthdays, anniversaries, etc.
- Busy view - showing your free and busy time over a four week period.

- To-do view - shows lists of things to do.
- Year planner - shows an overview of entries for the year, and displays entry symbols.

Switch between the views by tapping on the **View** button or by selecting the view from the **View** menu.

You can set preferences to change the way the views look. See 'Customising Agenda' later.

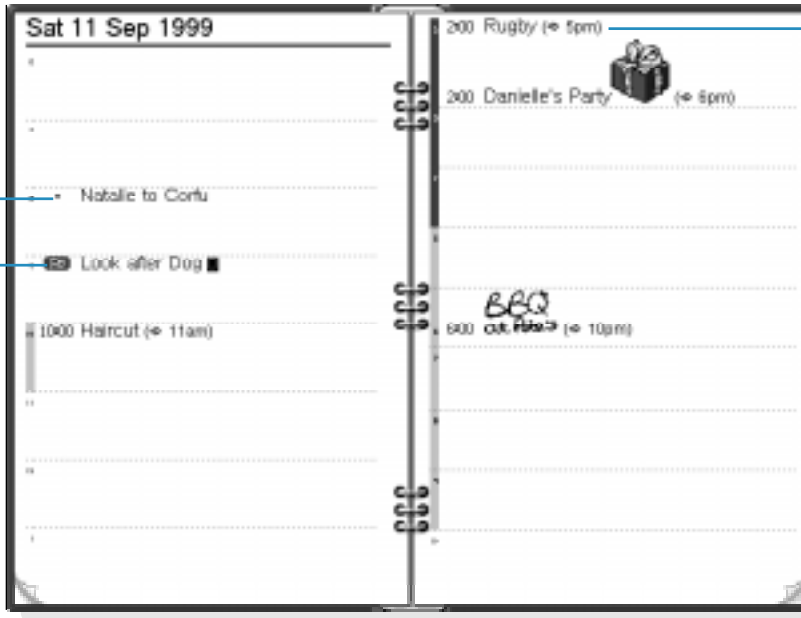

Untimed day entry

Event entry

Timed day entry





Entry symbols

You can group entries together using “entry symbols”. An entry symbol is a letter you can use to identify particular entries, for example, M for meetings. The entry symbol can also be used to show entries in the Year planner.

Birthdays and anniversaries

1. Move to the Anniversary view and just start typing, or select the command for creating a new anniversary entry from the **Entry** menu in any view.
2. Type in the details of the anniversary, e.g. ‘Jane’s birthday’ and set the day and month of the anniversary.
3. Press the **Alarm/More** button if you wish to specify other details about the anniversary, e.g. the start year and whether you want to see the start year (e.g. a person’s year of birth) and/or the number of years since the start year (e.g. their age).

Anniversaries are marked with a candle symbol ().

Reminders for entries - alarms

To set an alarm for an Agenda entry:

1. Move the cursor to the entry.
2. Set the alarm using the command from the **Entry** menu. You can also set an alarm while adding an entry, by pressing the **Alarm/More** button in the New entry dialog and then moving to the Alarm page.
3. Set the amount of warning that you want, or the time at which you want the alarm, and the alarm sound you want.

Initially you will see the list of standard alarm sounds, but you can add your own sounds for alarms using the Record program. See the ‘Customising your Series 7’ chapter for more details.

Entries which have alarms are marked with a bell symbol ().

- To remove an alarm, select the **Set alarm** command from the **Entry** menu and remove the tick from the alarm box.



Will alarms still ring if I close Agenda?

If you close an Agenda file, the Agenda informs the Series 7 clock to ring the next Agenda alarm at the appropriate time. However, the Series 7 will not be able to ring any further Agenda alarms from that file until you open it again.

If you use alarms a lot in your Agenda, it is therefore a good idea to leave the Agenda file open when you are not using it, even when the Series 7 is switched off.

If you do need to close the Agenda file, do not set an alarm and then immediately close the file or switch off. This is because the Agenda program needs a certain amount of time to calculate when the next alarm should ring, and if you switch off before the calculation is complete, the Series 7 clock will not have been informed to sound the alarm.

Alarmwarning

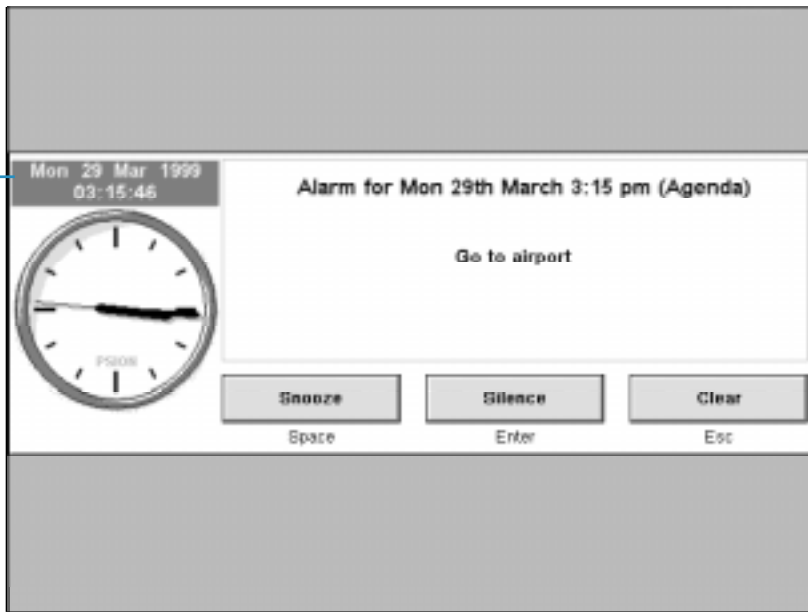



Finding entries and dates

You can search through the Agenda entries for a particular piece of text or for entries with particular settings, or a particular entry symbol.

1. Tap the **Find** button on the Toolbar or select the command from the **Edit** menu.
2. Type the text you want to find (you can leave the line blank if you want to list all of the entries). Select the dates you want to search using the range lines. Select any other settings as appropriate; press the **Options** button to select the entry types you want to find.

A list of matching entries is shown. Move the cursor to an entry in the list and press Enter to display it in full.

Use the commands from the **Edit** menu to go to the previous or next entry or to go to a specific day.

Using the calendar

You can also go to a specific day using the built-in calendar. Tap on the date titles or press Tab to display it in the Day, Week, or Anniversary views; alternatively select the **Calendar** command from the **View** menu in any view. Today's date is circled, and the currently selected date is highlighted. In a calendar you can:

- Press the buttons in the top of the calendar to see a 1, 3 or 12 month calendar.
- Tap on the “dog ears” in the bottom corners of the calendar to move between the calendar “pages”.
- Use the left and right arrow keys to move between days. Use Shift at the same time to move between dates in a month, Ctrl to move to the same day in the previous or next month, or Fn to move to the first or last date on the “page”.

When the highlight is on the day you want, press Enter to move to that day.

Changing and deleting entries

- **To move or copy an entry:** use the **Cut** or **Copy** commands from the **Edit** menu to move or copy an entry. Move the cursor to the new entry position and paste the entry. All entry details are transferred to the new location; alarm settings are adjusted accordingly.
- **To change an entry's "type", e.g. to change a day entry to an event:** highlight the entry you want to change and select the command from the **Entry** menu. Select the new entry type, and complete the settings for the new entry type.
- **To change the entry text:** highlight the entry you want to change and tap on it, or press Enter. Now you can edit the text, making use of the normal text selection and emphasis keys. If you wish to change the font, letter size, etc. press the **Alarm/More** button, then move to the Text page. You can also move an entry by editing the entry in this way and changing the entry time or date.

Deleting entries & crossing out

To remove an individual entry from the Agenda, select it and press Del or use the command from the **Edit** menu.

- You don't have to delete individual entries in the past, these can be removed automatically by "tidying" the Agenda file. See 'Tidying an Agenda file' later.
- If you want to mark an entry as completed, without removing it from the Agenda, move the cursor to it and cross it out using the command from the **Entry** menu. The entry will now appear in the Agenda views with a line through it, and any alarm for this entry will be cancelled.





Repeating entries

You can set an entry to repeat automatically, e.g. a monthly meeting.

1. Move the cursor to the entry and set the repeat using the command on the **Entry** menu.
2. Set up the repeat type as appropriate, e.g. Daily, Monthly, Weekly etc. You can also set the repeat to 'Monthly by date', e.g. the 7th of each month, 'Monthly by days', e.g. the first Monday of each month, 'Yearly by date', e.g. once every year on the same date or 'Yearly by day of week', e.g. the third Tuesday in March every year.
3. Press the **Alarm/More** button to set up the days and dates for the repeats (except for 'Daily' repeats). Set the interval for how many days, weeks, months or years you want between repeats.
 - If you only want the entry to repeat a few times, remove the tick from the 'Repeat forever' line and set the number of occurrences, or type in the date of the last occurrence on the 'Until' line.
 - If you only want to see the next occurrence of a repeated entry, you can choose to show 'Next only'.

Entries which are set to repeat are marked with ».

Note: If you select 'Next only' and the last occurrence has passed, you will not see the entry any more. Use the **Find** command from the **Edit** menu to be able to see them.

Lists and things to do

You can use a "to-do list" to note down tasks or items you want to remember. Initially you have two to-do lists, and you can add more lists later.

You can also give each item on a to-do list a due date, and assign priorities to to-do entries to control the order they appear in the Agenda views.

To-do entries are marked with a circled 'T' symbol (Ⓣ).

Adding a to-do

1. Move to the To-do view and just start typing, or create a new to-do entry using the command from the **Entry** menu.
2. Type in the details of the to-do, e.g. 'Buy paper'. The "Priority" can be used to determine the order in which to-do entries are listed in the to-do list, priority 1 is highest.
3. If the to-do entry has a deadline, press the **Alarm/More** button and tick the 'Dated' box. Then set the due date to the deadline date. If you want advanced warning of the deadline, set up warnings as appropriate. You can set how due dates are shown, e.g. Date, Days or Auto (date, days and 'tomorrow') if you want to see when the to-do is due.

Creating a new to-do list

You can create new to-do lists so that you can categorise the things you want to remember, for example you can keep a private to-do list and a work to-do list. Each to-do list is displayed on a “page” in the To-do view. Move between the to-do list pages by tapping on the “dog ears” in the bottom corners, or using the left and right arrow keys. Tap on the to-do list title to see a list of available lists.

1. Create a new to-do list using the command from the **To-do lists** menu.

2. Type in a name for the list, e.g. ‘Wedding plans’. You can rename the list later if you need to using the command from the **To-do lists** menu.
3. Specify the page number that you want this to-do list to appear on, and which to-do list you want to base the settings of the new list on.
4. Press the **OK** button to save the new list, and you’ll see the new list in the To-do view.

You can delete an unwanted to-do list and all its entries, using the command from the **To-do lists** menu.

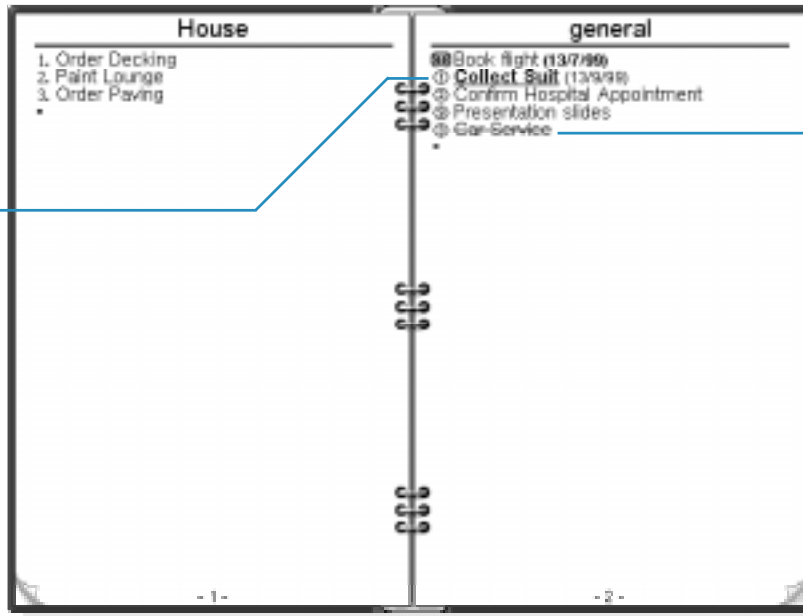

To-do priority

Crossed out entry





Customising a To-do list

You can change the way the to-do list looks and how to-do entries are shown in the Day and Week views.

Select **To-do list preferences** from the **To-do lists** menu.

- Each to-do list is displayed on a “page”; the page number controls the order in which the to-do lists are displayed. If you want to move the to-do list to another page, set the page number as appropriate.

- If you want to be able to arrange to-do entries on the list yourself, set the sort order to Manual. New entries you add to the list will appear at the cursor position, and you can cut, copy and paste to-do entries to put them in the order you want.
- Tick the boxes according to what you want to see in the To-do view and other views.
- If you want to see to-do entries in a specific time slot in the Day view, for example personal to-do entries in the evening, set the time as the standard position.

To-do entries
(standard
position at 8am)

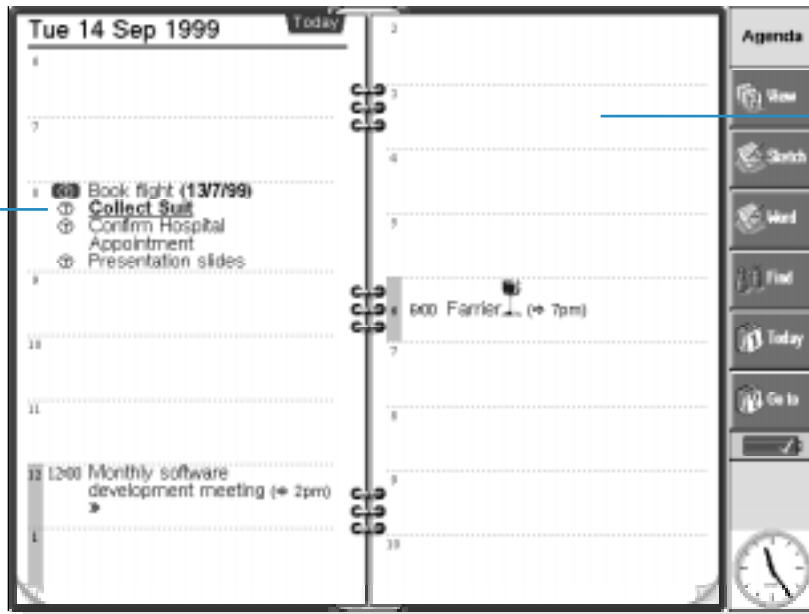

Customised
time slots

Information from other programs

You can use the **Paste** command to insert text copied in other programs straight in as an Agenda entry. For example, copy some text in Word using the **Copy** command, move to Agenda and to the position you wish the Agenda entry to appear and select **Paste**.

You can also insert information from other programs into an Agenda entry, e.g. add a sketch of a map to the entry for a meeting appointment. This information is called an “object”.

Attaching Word documents to entries

You can attach a Word document as a “memo” to any Agenda

entry, for example a list of things you want to discuss at a meeting. To do this:

1. Highlight the entry to which you want to attach the Word document.
 2. Tap the **Word** button on the Toolbar or select the command from the **Edit object** commands on the **Edit** menu.
 3. This takes you to a new Word document where you can type in your text. See the ‘Word’ chapter for more about using Word. When you have finished editing the document, close it to return to Agenda.
- To see or edit the document later, select the entry with the attached memo and then select the **Word** command again.

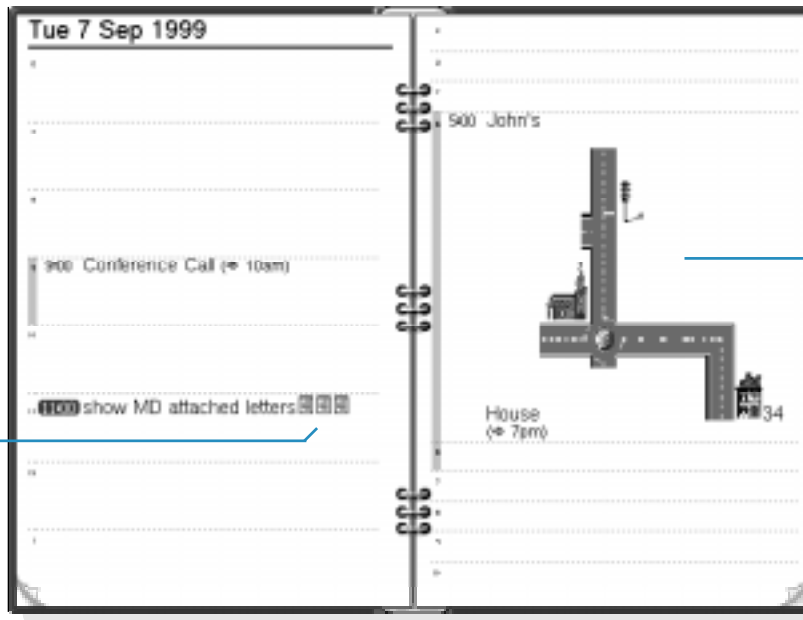

Inserted
Word objects

Inserted
Sketch object





Attaching a “voice note”

You can attach a spoken memo (a “voice note”) or another sound to any Agenda entry. To attach a voice note:

1. Select the entry to which you want to attach the voice note.
 2. Select the **Voice note** command from the **Edit object** commands on the **Edit** menu.
 3. This takes you to a Record file where you can make the recording in the normal way. See the ‘Record’ chapter for more about using the Record program. When you have finished making the recording, close Record to return to Agenda.
- To listen to the voice note later, select the entry with the attached voice note and then select the **Voice note** command again. Play the sound in Record and close Record to return to Agenda.

Attaching a sketch

You can add a sketch in one of 2 ways:

- by adding a sketch as an entry using the **Sketch** button in the Toolbar. You can add a picture, or handwritten note in this way. Just create the picture in Sketch and close the Sketch program to return to Agenda.
- by attaching a sketch to a text entry as an icon. Select the entry to which you want to add the sketch, then select the **Sketch** command from the **Edit object** commands on the **Edit** menu.

In either case, to see or edit the picture later, select the entry with the attached picture and then select the **Sketch** command from the **Edit object** commands from the **Edit** menu.

Customising Agenda

You can change the view that you see when you open the Agenda and set preferences for inserted objects by selecting the **General preferences** command from the **Tools** menu.

You can change the way each view looks by selecting **View preferences** from the **Tools** menu, while in the view.

- In the View preferences, you can select which type of entry you will add if you select an empty day or time slot and just start typing, press Enter or tap on an empty slot.
- You can also select which types of entry you want to show in the Day, Week and Year planner views.
- If you want to change the times shown in the day view to suit your working day, change slot definitions in the Day view preferences.
- If you only want to show one entry symbol in the Year planner, set the 'Show which symbols' line in the Year planner preferences to 'One'. Then select the entry symbol you want to show.

You can change the standard settings for entries by selecting **Entry preferences** from the **Tools** menu, and then selecting the entry type.

Agenda files

You may wish to keep separate Agenda files for business, hobbies and so on.

Create a new Agenda file for your information (using the command on the **File** menu).

- You can now add entries to the new Agenda file. You can use cut, copy and paste to move entries between Agenda files.
- If you have two Agenda files and want to combine them, use the **Merge** command from the **File** menu.

"Tidying" an Agenda file

You should tidy the Agenda on a regular basis to stop the file from getting too large. To do this:

1. Select the **Tidy/archive file** command from the **More** commands on the **File** menu.
2. You can select whether you want to copy or move old entries to a new file, or delete them. If you move or copy them to a new file, you must specify the name and location of the new file.
If you copy them to a new file, the entries are not removed from the current Agenda file.
3. Select which entries you wish to tidy, e.g. crossed out entries, and select the entry types you want to tidy by pressing the **Entry types** button.
4. Select the range of entries you want to tidy.

Note: If you have moved or copied entries to a new file, you should see the file on the System screen and be able to open it like any other Agenda file.





Printing Agenda entries

You can print all the Agenda entries, or limit the range you print to certain dates of interest, for example only the coming week.

- Before you print, refer to the 'Printing' chapter; this tells you how to set up the printer and page.

Tap the **Print** button on the Toolbar or select the **Printing** command from the **File** menu:

- Use the **Page setup** command to specify how the entries will appear in the printed copy. You can control the page size, margins, and add headers and footers. See the **Printing** section for more about this.
- Use the **Print preview** command to display pages showing how the printed copy will look.
- Use the **Print** command to print the entries.

When you select **Print** or **Print preview**, you'll see a dialog in which you specify the date range of the entries you want to print.

Press the **Entry types** button to set:



- Whether you want to print all repeat entries or only the next one.
- Whether you want to print crossed out entries.
- Whether you want to print only entries with a specific entry symbol.

Synchronising with a PC Scheduler

You can synchronise the Agenda with the PC agenda on your PC using PsiWin, to ensure that both agendas are kept in step with each other.

Note: Refer to the PsiWin on-line help for details of how to synchronise your diaries.

Synchronising entries with a PC scheduler

You can specify for each entry, whether you want to synchronise it with your PC agenda. Entries that aren't synchronised are marked with a  private entries are marked with a .

1. When adding or editing an entry, press the **Alarm/More** button in the entry dialog, then move to the **Other** page.
2. Tick the **Synchronise** box if you want to synchronise the entry with the PC agenda. Tick the **Private on synchronised agenda** box if you want to keep the entry confidential in the PC agenda.

To change the settings of a whole To-do list, select **Agenda synchronisation** from the **To-do lists** menu. If the To-do list is not synchronised, none of the individual To-dos will be. If the To-do list is set to Private, so are all individual To-dos.

Year view

Entry symbol

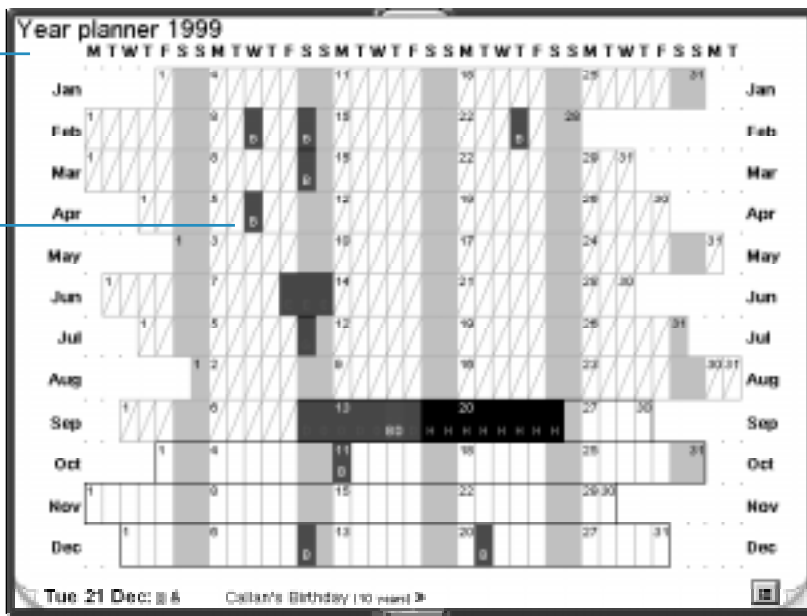



SETTING UP WEB AND EMAIL

Before Web and Email can be used on your Series 7, you need to set up ISP and Email account details.

Where to find out more

After you've set up email on your Series 7, you can find out more by consulting the:

- **Email on-line help**, for detailed information about setting up and using the Email program.
- **Email** and **Web** sections of this User Guide, for more information on sending and receiving email messages and using the Web application.
- **Email manual** (on the PsiWin CD ROM), for detailed information about setting up and using email, fax and SMS messages, and using the Email program.
- **Web on-line help**, for detailed information about using the Web program.
- **Web manual** (on the PsiWin CD ROM), for detailed information about using the Web program.



Displaying the on-line help.

To display on-line help about Email on your Series 7, open the **Email** program and select **Help on Email** from the **Tools** menu.

Before you start...

How can I use Web on my Series 7?

You can use your Series 7 to:

- Access the Internet and view web pages.
- View locally stored web pages and graphics files.
- Download files e.g. additional programs for your Series 7.

How can I use Email on my Series 7?

You can use your Series 7 to send and receive email messages using either one, or both, of the following methods:

1. **Connecting by telephone line to a 'Remote' mailbox.**
This is when you make a 'live' connection to your email mailbox via a telephone line (without needing a PC). For example, you could access your personal mailbox by dialling your Internet Service Provider (ISP), or access your work mailbox by dialling your company's service provider or office mailbox.



What to do next...

If you want to access your work mailbox, you will first need to contact your network administrator to find out whether you can make a 'remote' (dial-up) connection to your mailbox.

See 'What type of Email accounts can I use?' to continue.

2. **Connecting to a PC which can access your mailbox.**
This is when you connect directly to a PC which can access your mailbox. Using PsiWin's '**Email Synchronization**', you can write emails off-line on your Series 7, and then connect to your PC to send and receive messages.



How do I do this?

To access your mailbox via a PC, you will first need to install PsiWin on the PC and set up 'Email Synchronization'. **This guide does not include information on Email Synchronization. If you wish to use Email Synchronization see the PsiWin CD ROM.**

What type of email accounts can I use?

There are a number of different types of email account. See the list below to find out which types of account you can connect to using the Email program on your Series 7:

- **A personal 'dial-up' account.** This could be a dial-up email account which you've signed-up for with an Internet Service Provider (ISP), e.g. Freeserve or Pipex Dial.



Which ISPs can I use?

You can use most ISPs which use 'Internet standard' methods for connecting to your email account. However, some ISPs (such as America Online) use proprietary methods for connecting, and cannot be accessed by your Series 7 (i.e. you must use a PC).

Move on to 'Setting up your Series 7' to continue.

- **A 'remote' (e.g. office) email account.** This could be an email account at your workplace, e.g. using Lotus cc:Mail or Microsoft Mail.



How do I find out if I can use my account?

You will need to find out from your network administrator whether you can access your email mailbox using this type of account.

If you can, move on to 'Setting up your Series 7' to continue.

- **A Web based email account.** This is an email account which you must connect to using a Web browser, e.g. HotMail or Yahoo! Mail.



You can't connect to this type of account using the Email program.

To use Web based email, you must first set up your Series 7 for Internet access. To do this, follow all the stages in the 'Setting up your Series 7' section, *except* 'Setting up the Email program'. You will need to use the **Web** program to access your email provider's Web site.

If you don't have an Internet/email account

You will require an email account before you can access the internet and send and receive email messages on your Series 7.

- To get a personal email account, you must 'sign-up' with an Internet Service Provider (ISP). ISPs usually provide an email account as part of an Internet access package.
- Most ISPs will provide software (e.g. a CD ROM) which will help you set up Internet access and the email account on a PC.

Important: Some ISPs require that you connect to them using a PC in order to sign-up. If you can't do this, contact the ISP to find out if you can sign-up without using a PC. If you have Internet access, see "www.mobile.pSION.com" for more details.





Setting up your Series 7

What do I need to use Web/Email?

To access the Internet and send and receive email on your Series 7 you must have the following:

1. An appropriate **Email account**.
To access the Internet and use email, you will need an Internet 'standard' email account. See the 'Before you start...' section for more details.
2. A **Modem**.
You will need a modem to connect your Series 7 to the telephone network. You can use the following types of modem with your Series 7:
 - Standard external PC modems.
 - 'PC Card' modems.
 - Mobile phones with built-in modems.**Note:** if your mobile phone doesn't have a built-in modem, you will need to use it with a PC Card modem.

3. A **telephone connection**.
If you are using a standard external modem or PC Card modem, you will need to connect your modem to a telephone socket. If you are using a mobile phone, your network operator will need to enable your SIM (Subscriber Identity Module) card so that you can make fax and data calls on your phone. If your phone has been enabled for fax and data calls, you should have two extra phone numbers. Contact your network operator if you are unsure whether your phone's SIM card is 'data-enabled'.



Note:

If your mobile phone supports IrDA you can use it without the need for additional cables.



Getting help.

If you are having connection problems, you can find information about connecting using specific service providers, modems or mobile phones on our Web site at "www.mobile.pSION.com".

What information do I need?

Before you can set up your Series 7, you will need to find out some information about your modem and your Internet email account by:

- Checking any documentation your ISP supplied about your Internet account, or contacting your network administrator at work.
- Checking your ISP's Web site for technical support.
- Contacting your ISP by email or phone for technical support.
- Checking the Psion Web site at "www.mobile.pSION.com" for details of worldwide ISPs and to use the ISP configuration wizard.



Templates for popular service providers.

The PsiWin CD ROM contains 'templates' for popular Internet Service Providers, including those in the UK, US and Germany. You can use these templates to help you quickly set up your email account.

Information checklist

The checklist overleaf shows what information you will need to set up your Series 7. Only your ISP or your network administrator can supply all the information required about your Internet email account.

Glossary of terms

Email

An email (Electronic mail) is a text message which is sent over the Internet.

ISP

Internet Service Providers are companies which provide you with access to the Internet. An ISP 'account' normally includes the facility to send and receive email using a personal email address.

POP3/IMAP4

Internet 'protocols' (standards) for receiving email.

SMTP

An Internet protocol used for sending email.

TCP/IP

An Internet protocol used by computers to communicate with each other.

DNS

The Domain Name System is an address book which allows computers on the Internet to find each other by using 'IP addresses' and 'Hostnames'.

IP address

A computer's unique Internet address, e.g. "194.129.243.153", used by computers to communicate with each other.

Hostname

A human readable version of an IP address, e.g. "www.pSION.com" could be the same as the IP address "194.129.243.153".





Information you need

The **speed** at which you should use your modem (called the *baud rate*)

The **phone number** you need to dial to connect to your ISP (often called a *Point of Presence* or *POP*)

The **username** for your Internet account

The **password** for your Internet account

POP3 or **IMAP4** server address (for incoming messages)

SMTP server address (for outgoing messages)

Email address (your personal address)

Where to find it

Your modem's documentation

From your ISP/administrator

From your ISP/administrator, e.g. "jcrook" or "nd44"

From your ISP/administrator, or you may have chosen this yourself

From your ISP/administrator, e.g. "pop3.myisp.com"

From your ISP/administrator, e.g. "smtp.myisp.com"

From your ISP/administrator, e.g. "myname@myisp.com"

Write it here

Some service providers require additional information to 'log on' to their server. You may need the following information when using some service providers.

Optional information

Where to find it

Write it here

IP address (if your ISP's server doesn't provide one automatically)

From your ISP/administrator,
e.g. "194.129.243.153"

DNS addresses (primary and secondary DNS addresses if your ISP's server doesn't provide them automatically)

From your ISP/administrator,
e.g. "123.255.78.90" and "123.255.78.92"

Mailbox **login** (if different from your Internet account *username*)

From your ISP/administrator

Mailbox **password** (if different from your Internet account *password*)

From your ISP/administrator, or you may have chosen this yourself





Setting up Email on your Series 7

If you have collected all the information in the checklist, you are now ready to set up your Series 7 to connect to your ISP.

Connecting your modem

1. If you are using a PC Card modem:
 - Insert the modem into the PC card slot on your Series 7.
 - or if you are using an external PC modem:
 - Connect your Series 7 to the modem using the Series 7's serial cable.



What do I need to do this?

To connect your Series 7 serial cable to your modem you may require a Psion modem cable adapter. You can **only** use a Psion adapter, which can be obtained from your local distributor.

2. Connect your modem to the telephone socket and switch on the modem.

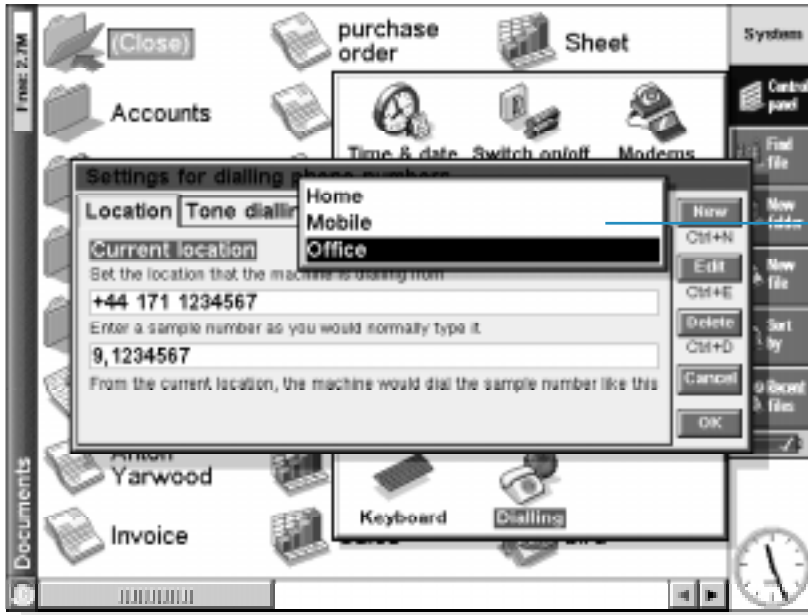

Location options

Setting up your dialling location

When you connect to the Internet, your Psion will need to dial your service provider's telephone. You can set up different dialling 'locations' so that your Series 7 knows how to dial the number correctly, e.g. if you're dialling from the 'office' location, you might need to add a '9' before the number you want to dial.

To set a dialling location:

1. Move to the System screen and tap the **Control Panel** button on the Toolbar.
2. Open the **Dialling** icon  to display the dialling settings.

3. Tap on the **Current location** line, and select the location you're dialling from:
 - Select 'Home' if you can dial without needing a prefix number.
 - Select 'Mobile' if you're using a mobile phone.
 - Select 'Office' if you need to use a prefix ('dial-out') number before dialling, e.g. '9'.

If you don't want to use any of these pre-defined locations, you can add a new location by tapping the **New** button and entering the appropriate details.



Settings for chosen location





4. Tap on **Edit** and check that the dialling settings are correct for your location (this is not necessary for the 'Mobile' location), e.g. you may need to change the **Area code**.
5. Tap **OK** when you have finished setting up your dialling location.

Setting up your modem

To specify the type of modem you are using:

1. Move to the System screen and tap the **Control Panel** button on the Toolbar.

2. Open the **Modems** icon  to display the modem settings.
3. Tap on the **Current modem** line, and select the modem you're using:

Select 'Generic modem settings' if your type of modem isn't shown. If the generic settings don't work for your modem, tap **New** to add a new entry for your modem. See the documentation supplied with your modem for the required settings.

4. Tap **OK** when you have finished setting up your modem.

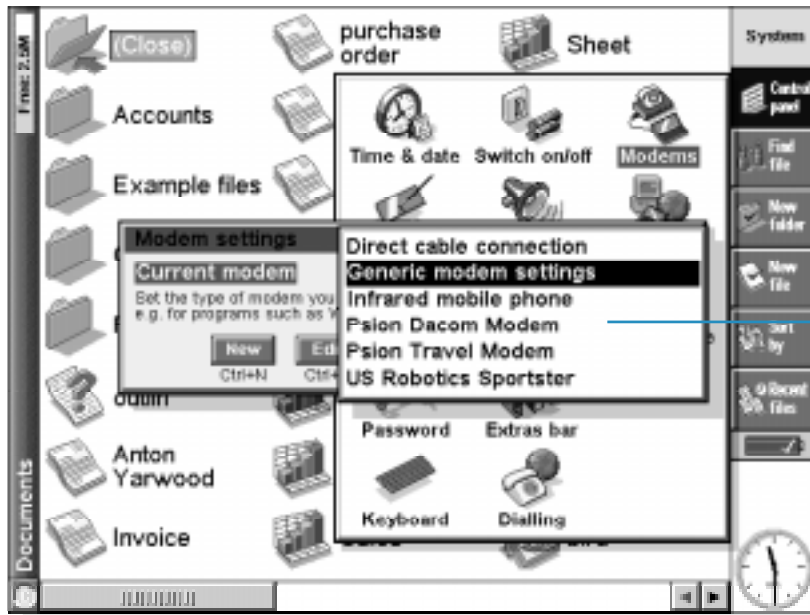

Modem options

Setting up your Internet service

Once you have set up your dialling location and modem, you need to create a new 'Internet service' and enter your Internet account settings for your service provider. See 'What information do I need?' earlier for more details on the information required.

To set up your Internet service:

1. Move to the System screen and tap the **Control Panel** button on the Toolbar.
2. Open the **Internet** icon  to display the Internet service settings.
3. Tap **New** to create a new Internet service (account).
4. On the **Based upon** line, select 'Standard settings', or if you have a 'template' file containing your ISP settings, select 'Settings from file' and choose the file.
5. On the **Service** page, enter a name for your account and enter your service provider's *dial-up number* (or *POP* phone number).

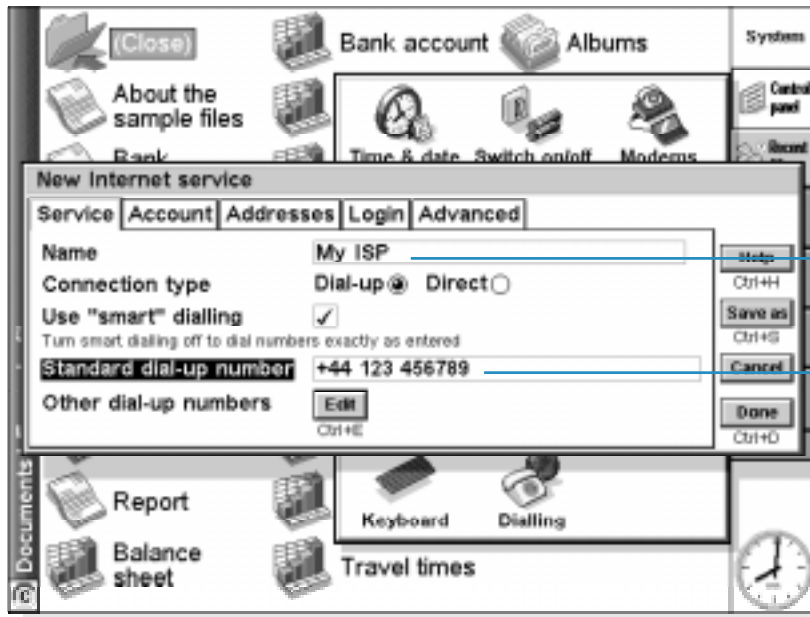

Enter a name for your new account

Enter a valid access phone no.





- On the **Account** page, remove the tick from **Manual login** and enter the *username* and *password* for your Internet account.

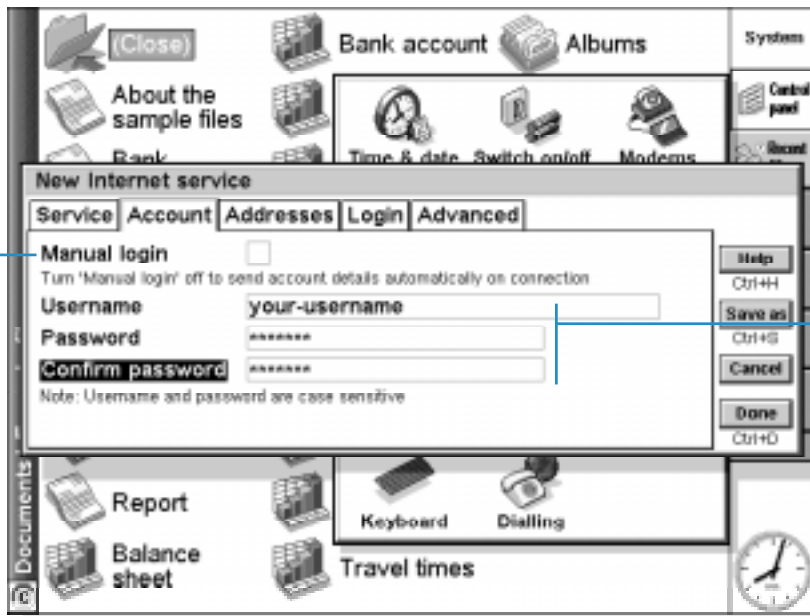

Untick this option

Enter your username and password

- If your service provider requires you to specify *IP* and *DNS* addresses, you can set these on the **Addresses** page. Before you can enter IP and DNS addresses, you must first remove the ticks from the **Get IP address from Server** and **Get DNS address from server** boxes.
- When you have finished entering the settings, tap **Done** to return to the 'Internet service settings' dialog. The new service you've created will be shown on the **Current Internet service** line. Tap **OK** to return to the Control Panel.



What if I need to use a 'login script'?

Some Internet Service Providers require that you use a login script when you connect, e.g. to send details such as your *username* and *password*. You can type in a login script on the **Login** page of your Internet service settings. See the **Email manual** on the PsiWin CD ROM for more information on writing login scripts.

Either tick the box or enter a valid IP address

New Internet service

Service Account Addresses **Login** Advanced

Leave 'Get address...' lines ticked unless your service provider has told you to specify the IP and DNS addresses yourself

Get IP address from server

IP address 111.222.33.44

Get DNS address from server

Primary DNS address 12.34.56.78

Secondary DNS address 123.45.67.89

Help Ctrl+H
Save as Ctrl+S
Cancel
Done Ctrl+D

Either tick the box or enter valid DNS addresses





Setting up the Email program

Once you have set up your Internet service, you can set up your email account in the Email program.

To create a new account in Email:

1. Tap on the **Email** program icon .
2. Select **Email** from the **Add new account** command on the **Tools** menu.
3. On the **Account** page:
 - Enter a name for your account (this can be anything you want).
 - Enter your name as you want it to appear on all emails you send on the **Your name** line.
 - Enter your *email address*, e.g. “my.name@myisp.com”.
 - If the **Mailbox type** line is displayed, choose the mailbox type, e.g. ‘POP3’ or ‘IMAP4’.

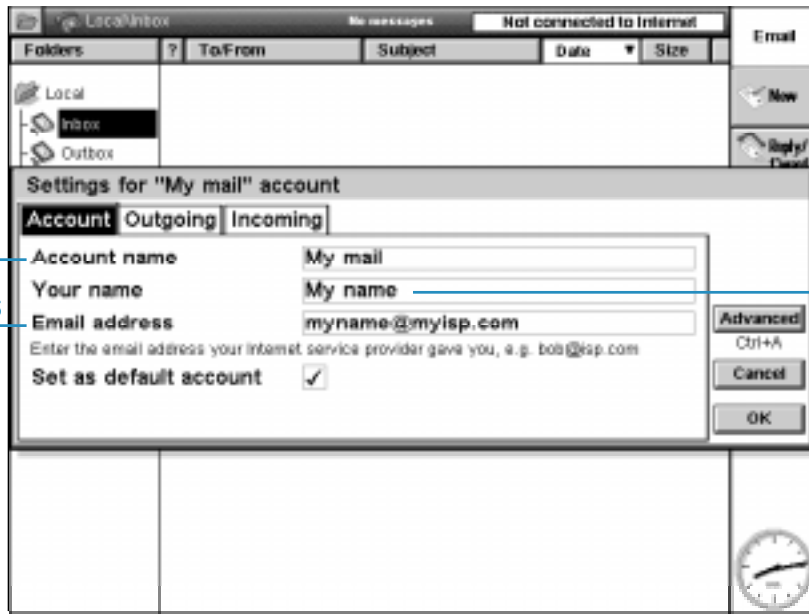

Enter a name for your account

Enter email address

Enter a name that you wish to appear on your messages

4. On the **Outgoing** page:

- Enter your outgoing mail (SMTP) server address, e.g. "smtp.myisp.com".

Enter your
OUTGOING mail
server address

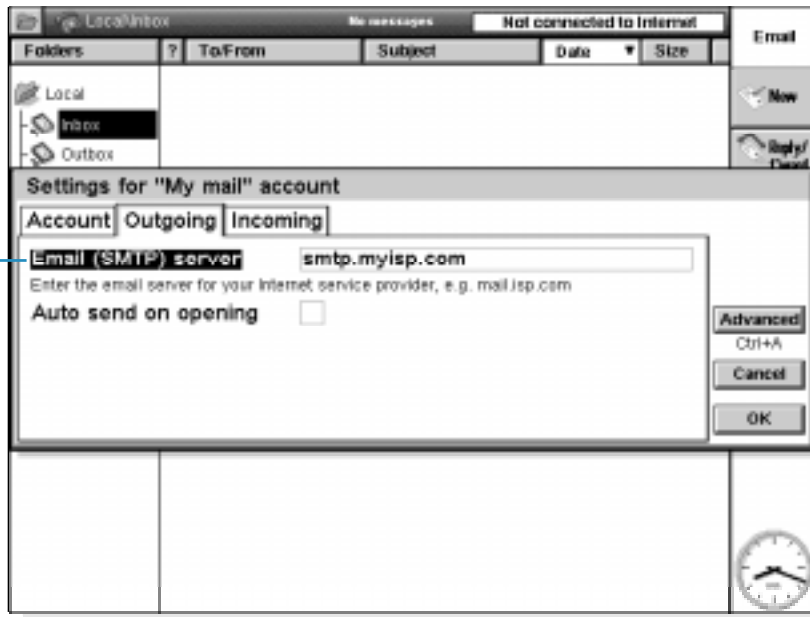



5. On the **Incoming** page:
- Enter your incoming mail (POP3 or IMAP4) *server address*, e.g. "pop3.myisp.com".
 - Enter your mailbox *login* (or *username*) and mailbox *password* (these may be the same as your Internet *username* and *password*).

6. Tap **OK** when you've finished entering your email account settings.

You are now ready to use your Web and Email applications.

Enter your **INCOMING** mail server address (POP3 or IMAP4)

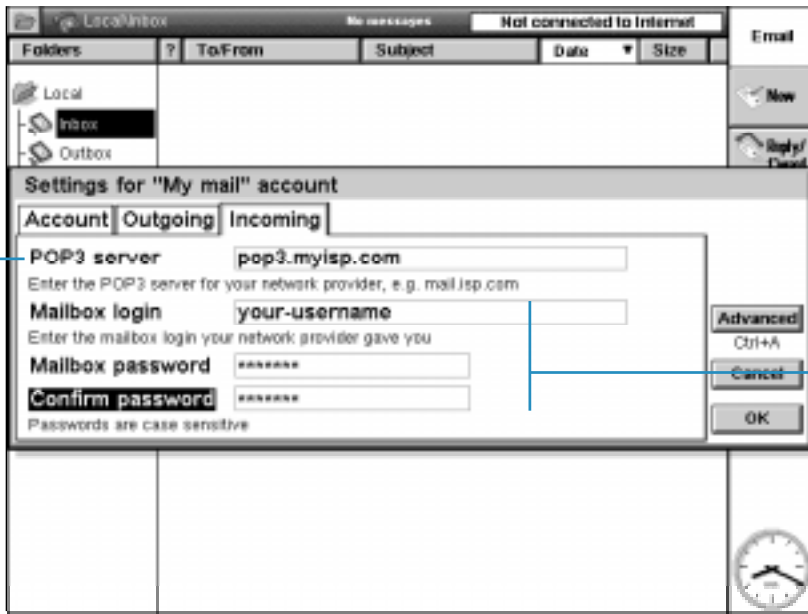

Enter your mailbox username and password

WEB

Web is the Internet World Wide Web browser. Use it to:

- Connect to the Internet and view Web pages.
- View locally stored Web pages and graphics files.
- Download files, e.g. additional programs for your Series 7, from Web sites.

Read this first

Before you can browse the Internet, you will require:

- A modem
- A telephone connection
- An Internet Service Provider (ISP) account.

For information on setting up your Series 7 to connect to the Internet, see the 'Setting Up Web and Email' section.

Navigating the Web

To start a connection and open a Web page:

1. Connect your Series 7 and modem to a telephone line, and make sure the **Modems**, **Dialling** and **Internet** sections of the Control panel are set up correctly.
2. Tap on the  icon, then tap in the location line at the bottom of the screen and enter the location (URL) of the Web page you want.

To stop loading a page:

Tap the  button on the Toolbar, or select **Stop** on the **File** menu.

To close a connection:

Select **Disconnect from Internet** on the **File** menu.



If you use **Disconnect from Internet** while other programs, such as Email, are busy using the connection, you risk losing information in them. To avoid this, make sure no programs are transferring information to or from the Internet when you disconnect.



**To follow a link:**

- Hypertext links (links to other pages) are underlined.
- Tap on the link once to select it, then tap on it again to open the page it leads to. Alternatively, use the Tab key to highlight different links on a page in turn, then press Enter to open the highlighted link.

To navigate between pages:

- Use the  and  buttons to move back and forward between the pages you have already viewed.
- Use the  button to display a list of the pages you have viewed. To open a page, select one of the pages and tap on it again or tap **Go to**.



Status

Toolbar

History list

Forward

Back

Link

Location line

Saving pages

You can save a Web page to your Series 7 so that you can view it again without having to connect to the Internet.

To save the current page:

- Select the **Save as** command from the **MORE** command on the **File** menu. Give the file a name and location and tap **OK**.

When giving the file a name, it is important to add the “.htm” or “.html” filename extension, e.g. “home.htm”.

To open a page you’ve saved to a local disk:

1. Select **Open file** from the **File** menu, then locate the file and tap **OK**.
2. Tap on the file in the System screen, then press Enter or tap on it again.

Web can only open local Web pages which have the “.htm” or “.html” filename extension.

Saved pages will not normally contain images. This is because Web page images are separate files displayed with the page by the Web browser.

Links on a saved page often refer to pages stored on the Internet, so you may need to connect before you can open them.

You can copy the text on a page and paste it into another program, e.g. Word.

To do this:

1. Drag the pen across the area of text you want to copy, or use **Select all** on the **Edit** menu to highlight all the text on a page.
2. Select **Copy** on the **Edit** menu, then move to the program you want to place the text into and use the **Paste** command.

To save an image displayed on a Web page:

1. Select the image by tapping on it or by pressing Tab until the image is highlighted (this is indicated by a dotted line appearing around the image).
2. Select the **Save image as** command from the **More** command in the **File** menu, enter a filename and location and tap **OK**. The image will be saved using the same file format as the original file on the Internet.

If you want to open an image file using Web, the filename extension must match the image file format. Make sure there is a “.gif” at the end of the filename if it is a GIF image; “.jpg” if it is a JPG image; or “.mbm” if it is an MBM image.

To view a saved image:

- Use **Open file** on the **File** menu and select the image file you want to open. Web can open image files in JPG and GIF formats. It can also open MBM images when they are stored locally. (MBM format is the same as EPOC Picture format.)





Customising

Home and search pages

Your home page is the first page displayed when you open Web.

- To set a home page, select **General preferences** on the **Tools** menu and type the location of the required page in the **Home page location** line.
- To open a home page, tap on the **Home** button on the Toolbar or select the command from the **Go to** menu.

A search page is a Web page that you use to search for information contained in other Web pages. You can follow links based on the results of your search.

To set up a standard search page:

1. Select **General preferences** on the **Tools** menu.
2. In the **Search page location** line, enter the address of your preferred search site and tap **OK**.

To open your standard search page:

- Tap  on the Toolbar, or select **Search page** on the **Go to** menu.



Images

Web pages are made up from text and images. You can choose whether to display images in a page. To do this, select **Display preferences** from the **Tools** menu and use the **Load images automatically** box .

Using bookmarks

You can 'bookmark' pages you wish to return to later.

To add a bookmark for the current page:

- Tap the **Add bookmark** button on the Toolbar, or select the **To current page** command from the **Add bookmark** command in the **Edit** menu.

To go to a bookmarked page:

1. Tap the  button on the Toolbar, or select **Bookmark manager** on the **Go to** menu.
2. Select the bookmark and tap on it again or tap **Go to**.

You can organise bookmarks using folders, in much the same way as you manage files in the System screen.

To organise your bookmarks:

- Select **Bookmark manager** on the **Go to** menu.
- To return to the current Web page, tap on the **Done** button on the Toolbar or select **Page view** on the **Go to** menu.

In the Bookmark manager:

- **To go to a bookmarked page:** Select the bookmark and tap it again or tap the **Go to** button.
- **To change a bookmark:** Select the bookmark and tap the **Edit** button. Enter the new name or location and tap **OK**.

- **To add a bookmark:** Tap the **Add bookmark** button on the Toolbar or select the command on the **Edit** menu. Enter the name and location of the page you want to bookmark and tap **OK** or press Enter.
- **To create a bookmark folder:** Tap the **New folder** button on the Toolbar or select the command on the **File** menu, then enter the folder name and tap **OK** or press Enter.
- **To move or copy a bookmark or folder:** Select the item, then select **Cut** or **Copy** on the **Edit** menu. Move to the position you want to place the bookmark or folder and tap **Paste**. If you want to move or copy a bookmark to an empty folder you must first open the destination folder.
- **To remove a bookmark or folder:** Select the item, then select **Delete** from the **Edit** menu.
Removing a folder will also delete all the bookmarks and folders it contains.
- **To find a bookmark or folder:** Tap the **Find** button on the Toolbar or select the **Find** command from the **Find** command in the **Edit** menu. Enter the text you want to search for and tap **OK** or press Enter.
- **To export your bookmarks as HTML:** You can save your bookmarks as an HTML file so that you can use them as a home page, or transfer them to a Web browser on another machine. To do this:

Select the **Export as HTML file** command from the **More** command in the **File** menu. Enter a name and location for the file. Ensure the file has an “.htm” or “.html” extension.

You can use **General preferences** on the **Tools** menu in the Page view to set this file as your Home page.





Using forms

Some Web pages, such as search sites, contain “forms” which require you to enter information using “controls”, e.g. radio buttons and text boxes.

Forms can contain any of the following controls:

- **Text entry boxes:** to use these, tap once on the box, then start typing.
- **Password boxes:** these are similar to text entry boxes, but the characters you type in are disguised for security reasons.
- **Lists:** these contain a list of options displayed in a box. Tap on the arrows on either side of the box, or use the arrow

keys to move through the list.

- **Radio buttons and check boxes:** these are the same as the controls used in Series 7 dialogs. Simply tap on the appropriate box or button to select the option(s) you want.
- **‘Clear’ and ‘Reset’ buttons:** many forms have a **Clear** or **Reset** button, which resets all the form’s items to their original state.
- **‘Submit’ button:** most forms have a **Submit** or **Proceed** button that sends the information you have entered in the form.

Entering information in a form may be slow until the page has finished loading.

Listbox

Radio buttons

Submit button

Textbox

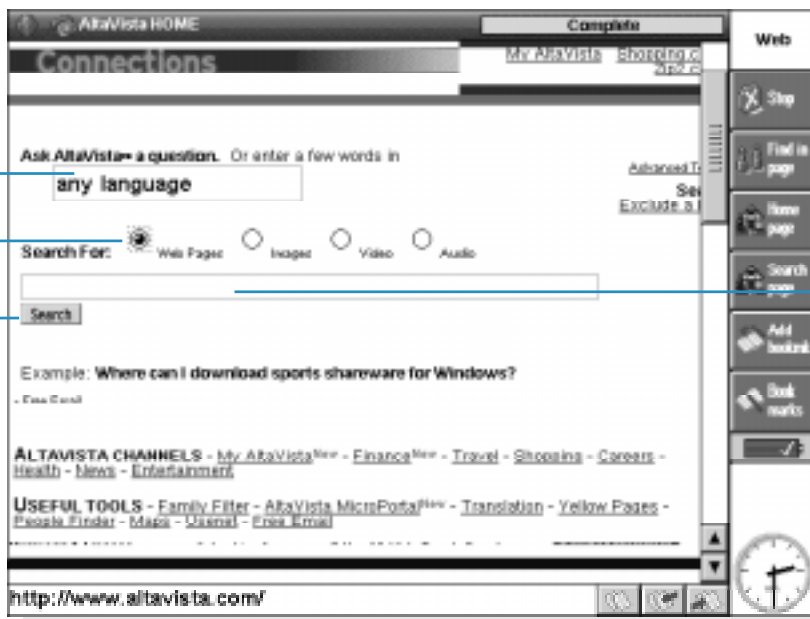

Loading images

Web pages containing images may take longer to open than text-only pages. To reduce the time it takes to open a page, you can set Web so that it does not load images.

To do this:

- Select **Display preferences** on the **Tools** menu and remove the tick from the **Load images automatically** box.

If Web is set not to load images, it will display  icons instead. There may also be accompanying text describing the image.

To display a single image:

- Tap on the  icon once to select it, then tap again or press Enter to open the image, or select **Load image** on the **View** menu.

If an image icon contains a link to another Web page, you can tap on it again or press Enter to open the page.

If you have **Load images automatically** turned off, the icon for an image which contains a link will be slightly different, e.g.. Select the

 icon once, then tap on it or press Enter to open the linked page. Select **Load image** on the **View** menu to display an image that contains a link.

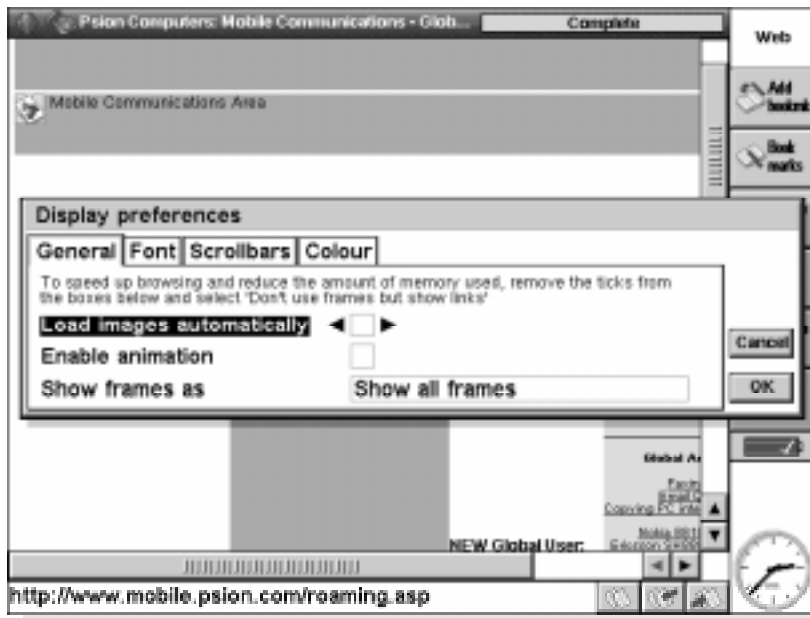



To display all the images on the current page:

- Select **Load all images** on the **View** menu.
An image may contain a link to another page. Tap on an image to display its link.

To open the page from a linked image:

- Tap on the image to select it, then tap on it again or press Enter.
Some images on Web pages contain more than one link. These are called “image maps”. To use these, tap on the image once, then tap again on the area containing the link you want to follow.

Some images are animated. You can set whether these images are displayed as static pictures or as animations.

To do this:

- Select **Display preferences** on the **Tools** menu and use the **Enable animation** box.
Web supports JPEG and GIF images. It also supports MBM format images (this is also known as EPOC picture format) when they are stored locally.

Downloading files

You can use Web to download files from Web sites, e.g. software for your Series 7.

To download a file:

1. Either select a link from which you know you can download files, or use **Open web page** on the **File** menu.
2. When Web contacts the remote machine, you will see:
 - A dialog telling you that the file can be opened using another program on the machine. In this case, tap **Open** to save and open the file, or **Save** to just save it.
or
 - The **Web cannot open this file** dialog. In this case you should tap **Save** in the dialog to save the file, then give the file a name and location and tap **OK**.
or
 - A page with links to files and folders. To download a file, tap on one of the files within the displayed folder. You will then see a dialog saying that Web cannot open this file. Select **Yes** in the dialog to save the file, then give the file a name and location and tap **OK**.



Note:

Many archive file formats you can download from the Internet may not be recognised by your Series 7, e.g. files with the .ZIP filename extension. If these archives contain software for your Series 7, you may need to use a PC to extract files from these archives before you can install them on your Series 7.

Cache & memory usage

To open Web, connect to the Internet and load a page with graphics, you should ensure your Series 7 has around 2000K free.

Web can keep local copies of the Web pages you've viewed during any one session, so you can open them more quickly and even view them when you're not connected to the Internet. You can change the size of this "cache" according to the amount of memory you have free.

To change the size of the cache:

- Select **General preferences** from the **Tools** menu, tap on the **Other** page and enter the **Maximum cache size** that you want.
- The cache is cleared when you close Web. To stop this, select **General preferences** from the **Tools** menu, tap on the **Other** page and remove the tick from the **Empty cache on exit** box.

To view or clear the contents of the cache:

- Select the **Cache** command from the **Information** command in the **Tools** menu. A list of the files stored in the cache will be displayed. Tap **Empty now** to remove all the files and free memory.

Using proxy servers

A proxy Web server is a remote machine that stores a large number of Web pages. You can use a proxy server as a single point of Internet Web access. By setting Web to use a proxy server, you may be able to retrieve pages more quickly.

To set a proxy server for Web pages:

1. Select **Proxy server settings** on the **Tools** menu.
2. Select the Internet service provider you want to use the proxy server for, and select 'http' in the '**Protocol**' line.
3. Tick **Use proxy server** and enter the address for the proxy server in the **Proxy server** line.
4. In the **Port number** line, enter the port that you wish to use to access the remote machine. You may need to contact your Internet service provider for this information and the server's address.

Proxy exceptions:

You can specify 'exception' Web addresses that will be excluded from the proxies you have set up. To do this:

1. Select **Proxy server settings** on the **Tools** menu.
2. Select the Internet service provider for which you have set up the proxy, then tap on the **Exceptions** button.
3. Use the **Add** button to add exception addresses for which you don't want to use the proxy server.

You can delete proxy exceptions by tapping the **Remove** button.





Customising the display

You can use the display settings to show more of a page on the screen.

- **To change the size of the information on the screen:** Use the **Zoom in** and **Zoom out** commands on the **View** menu, or the command icons on the side of the screen.
- **To show or hide the Toolbar:** Use the **Show toolbar** command on the **View** menu.
If you hide the Toolbar, the Toolbar buttons appear at the end of the location line.
- **To show or hide the Title bar:** Use the **Show title bar** command on the **View** menu.
- **To hide or change the position of the location line:** Select **Show location** on the **View** menu and use the **Top**, **Bottom** and **Off** commands.
- **To show or hide the scrollbars:** Select **Display preferences** on the **Tools** menu and use the radio buttons on the **Scrollbars** page. If you select **Auto**, the scrollbars will only appear when they are needed.
- **To change the fonts used in the browser window:** Select **Display preferences** on the **Tools** menu and specify the typefaces and font sizes to use for Web pages.

Keypresses

The default keypresses are:

- **Tab** to cycle forwards through each link or form control on a page and the location line in turn.
- **Ctrl+Tab** to cycle through frames (if available). You can then use the arrow and tab keys to navigate around within the active frame.
- **Shift+Tab** to cycle backwards through the links, form controls and location line.
- **Enter** to follow a selected link, or to load a selected image.
- **Esc** to put the cursor in the location line.
- In the Bookmarks dialog and the Bookmark manager, use the **Tab** key to open or close a highlighted folder.

Status information

You can view status information about your connection to the Internet at any time.

To do this:

- Tap the title bar, or select the **Status** command from the **Information** command in the **Tools** menu.

The Status information dialog displays the following details about your connection:

Connection: Whether or not you are currently connected to the Internet.

Page title: The title of the Web page currently displayed.

Location: The full Web address of the page currently displayed.

Status: Web's progress in retrieving the current page.

To view information about the page you have open:

- Tap the title bar, or select the **Page** command from the **Information** command in the **Tools** menu.

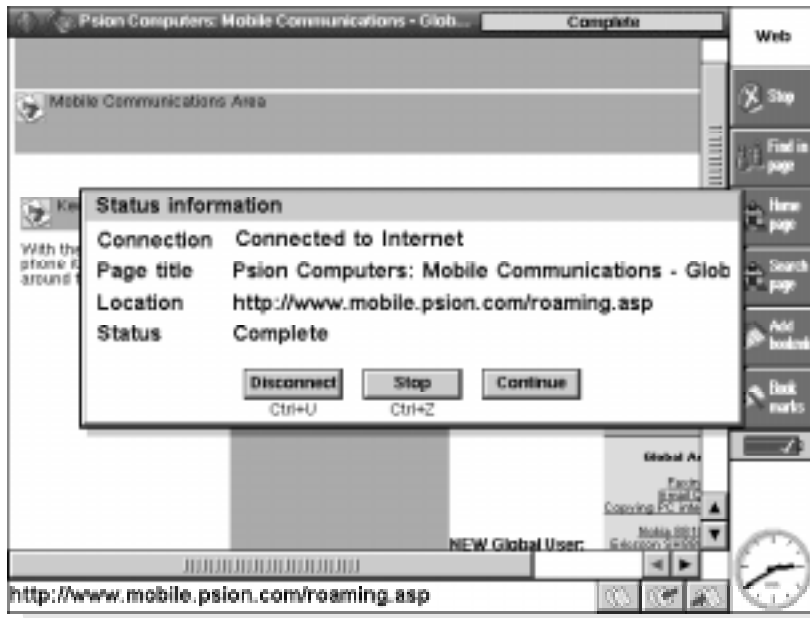



Fonts

Use **Display preferences** on the **Tools** menu and tap on the **Font** page to change the fonts used in the browser window:

- Use the **Standard font** line to change the font that is used for normal text on a page.
- Use the **Fixed width font** line to change the font used for “system” text, e.g. a message from a server.
- Use the **Base font size** line to alter the size of normal text. Web will adjust the relative sizes of fonts used in all headings accordingly.



Sending mail from a Web page

Some Web pages have links for sending email directly from your Web browser. When you select this type of link, a **'mailto:'** prefix appears in the address displayed in the top right hand corner of the screen.

When you complete a form on a Web page and tap the Submit button you might find that the Email program opens, and the content of the form is displayed in an email message. If this happens, you need to send the message using the Email program. See the Email on-line Help and documentation for more details.

To send mail from a Web page:

1. Tap on the link to select it. Check that the link begins with **'mailto:'**.
2. Tap on the link again or press Enter. This will open Email's 'message editor'.
3. Enter your message subject and text. The **'To:'** line of the message will already be completed using the address specified in the **'mailto:'** link.
4. When you've finished writing your message, tap the **Save to outbox** button on the Toolbar.
5. If the Email message editor is already open, when you use a **'mailto:'** link in Web, the message you were working on is saved in the Draft folder.

Finding text on a Web page

You can search for characters, a word or a phrase on a Web page you have opened.

To do this:

1. Tap the **Find in page** button on the Toolbar or select the **Find** command from the **Find** command in the **Edit** menu.
2. Enter the text you want to search for and tap **OK**.

You can use the following search options:

- **Direction:** use the **Up** and **Down** radio buttons to searches up or down from the point you selected on the Web page.
- **Match whole word:** use this to only find the text that you entered if it appears as a whole word, e.g. a search for **'web'** will not find **'website'**.
- **Case sensitive:** use this option to only find text which exactly matches the case of the letters you entered, e.g. a search for **'Web'** will not find **'web'**.

After a search, you can look for further occurrences of the same text by selecting the **Find next** command from the **Find** command in the **Edit** menu.





Plain text authentication

If you have disabled plain text authentication and your Series 7 cannot log in to your Internet service, you'll see the message:

Internet service server only allows plain text authentication

This means that in order to log in to this server you have to enable plain text authentication.

Using plain text authentication means your password is sent to the server without being encrypted first. You may consider this to be a security risk: contact your Internet service provider if you are in doubt.

To enable plain text authentication:

1. Open the **Internet** section of the Control panel in the System screen.
2. Select your **Current Internet service** and tap the **Edit** button.
3. On the **Advanced** page, tick the **Allow plain text authentication** box.

Cookies

If you see a Cookie information dialog, this is because a Web site you have contacted has asked to store a 'cookie' on your Series 7.

Cookies are small files which store your personalised information and settings for a Web site. Other sites may read the information in your cookie files, so although they are normally harmless, you may want to stop using them for confidentiality reasons.

To stop using cookies:

1. Select **General preferences** on the **Tools** menu and tap on the **Other** page.
2. In the **Use cookies** line, select **Never**. Select **Ask** to be prompted each time a site wants to put a cookie on your Series 7.

Viewing HTML source

You can use Web to look at the HTML 'source code' of Web pages you have retrieved. This may be useful if you are interested in creating your own HTML pages and want to see how an effect is achieved.

To view the source of the current page:

1. Select **Show page source** on the **Tools** menu.
2. Web will display the HTML source. This may require a connection to the Internet if you aren't connected.
3. Once the HTML source code has been retrieved, you can view and edit it. Use the **Save as** button or select the **Save as** command from the **More** command in the **File** menu to save the HTML text as a ".HTML" file on your Series 7.

To view the Web page as normal:

- Tap the **Done** button on the Toolbar or select **Show page source** on the **Tools** menu again to remove the tick.

Using plug-ins

Plug-ins are programs you can use with Web to add new features and capabilities for browsing the Internet. You will be able to find Web plug-ins by searching for them on the Internet.

To add a plug-in:

Select the plug-in installation file in the System screen, then tap on it again to install it.

Some plug-ins can require a considerable amount of memory, so you may want to turn them off when you are not using them.

To do this:

1. Select **General preferences** on the **Tools** menu and tap on the **Plug-ins** page.
2. Select the plug-in you want to turn off, and tap the **On/Off** button. To turn a plug-in back on, select it and tap the **On/Off** button again.





EMAIL

You can use the Email program to send and receive:

- **Email** (electronic mail) messages.
- **Fax** messages.
- **SMS** (Short Message Service) messages, i.e. text messages on mobile phones.

Read this first

Before you can send and receive messages you will require:

- For **Email** messages: an email account, a modem and a telephone connection.
- For **Fax** messages: a telephone connection.
- For **SMS** messages: a supported mobile phone and an appropriate SMS account with a telephone network.



Note:

If your mobile phone supports IrDA you can use it without the need for additional cables.

For information on setting up your Series 7 for Email, see the Setting Up Web and Email section.

Finding your way around...

When you first open Email, you will see the 'Folders' view which displays your mailboxes, folders and messages. The 'Local' folders (on the left) are stored on your Series 7, so you can create and view messages in these folders when you aren't connected.

When you have set up an email account, a 'Remote' mailbox  will be displayed (with the name you gave your account) below the Local folders. When you connect, you can transfer (or 'download') incoming messages from your Remote mailbox to the Local folders on your Series 7.

The following Local folders are displayed:



Inbox: contains your messages when you have transferred them from your Remote mailbox.



Outbox: contains outgoing messages which you can send when you next connect.



Draft: contains unfinished messages you are still writing.



Sent: contains copies of messages you have sent.

You can use Local folders in the same way as you use folders in the System screen, e.g.:

You can create a new folder by tapping the **New** button on the Toolbar and selecting **Folder**, or by using the command on the **File** menu.

You can move and copy messages between folders by using the commands on the **Edit** menu.

Managing emails





When you first open Email, you will see the "Folders" view which displays your mailboxes, folders and messages. The "Local" folders (on the left) are stored on your Series 7, so you can create and view messages in these folders when you aren't connected.

If you have set up an email account, a "Remote" mailbox will be displayed  (with the name you gave your account) below the Local folders. When people send email messages to you, they will be kept in the Remote mailbox until the next time you connect to it. When you connect, you can transfer (or 'download') messages from your Remote mailbox to the Local folders on your Series 7.

Note: If you haven't set up an email account yet, see 'To find out more' at the end of this chapter for details.

Local folders

When you open Email, the following Local folders are displayed:

-  **Inbox:** contains your incoming messages when you receive them.
-  **Outbox:** contains outgoing messages which you can send when you next connect.
-  **Draft:** contains unfinished messages you are still writing.
-  **Sent:** contains copies of messages you have sent.

You can use Local folders in the same way as you use folders in the System screen:

- You can create a new folder by tapping the **New** button on the Toolbar and selecting **Folder**, or by using the command on the **File** menu.
- You can move and copy messages between folders by using the commands on the **Edit** menu.

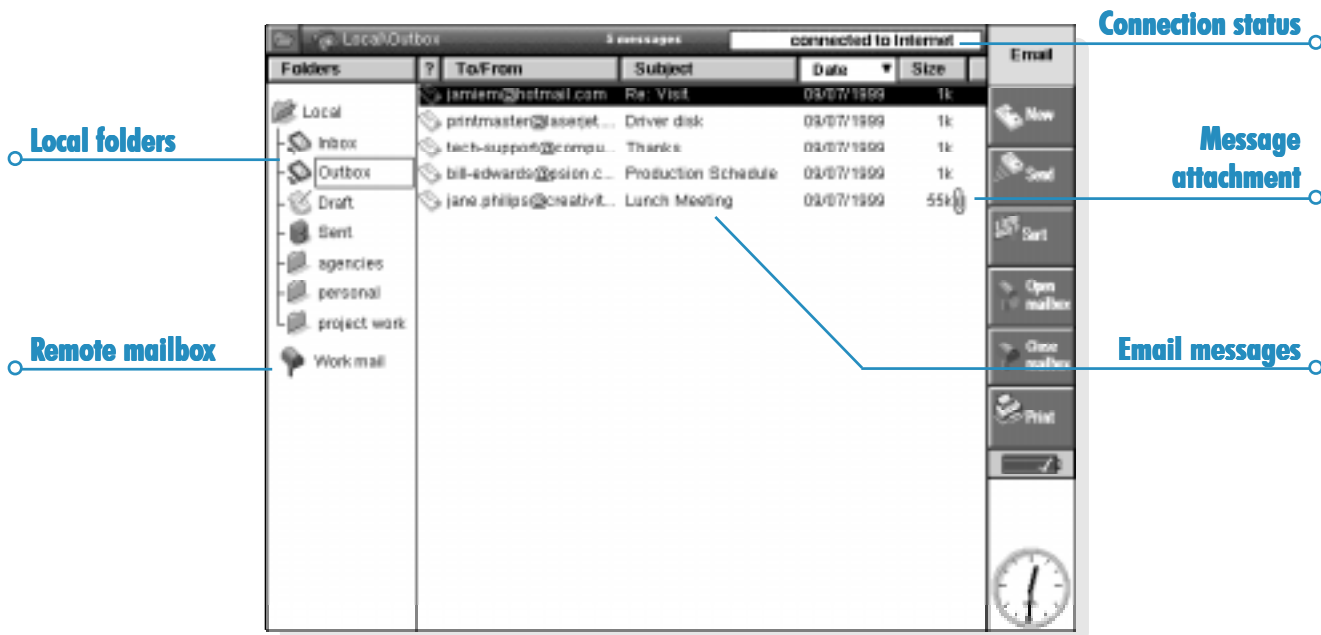



Writing an email

You can write a new email message while working “off-line”, then save it to a Local folder on your Series 7 so you can send it when you next connect. You can save messages in the Draft folder if you want to edit them before sending, or save them in the Outbox folder if you want to send them when you next connect.

Note: You do not need to be connected to your email account (Remote mailbox) to prepare, read and respond to messages; the only time you need to connect is when you wish to send or receive messages.

To write a new email:

1. Tap the **New** button on the Toolbar and select **Email**, or use the command on the **Message** menu. Email displays the “message editor” in which you can write your message.
2. To enter the email address(es) of the recipients of your message, use the following lines:
 - **To**: main recipient(s) of your message.
 - **CC**: recipient(s) you want to send a “carbon copy” of the message to.
 - **BCC**: recipients you want to send a “blind carbon copy” of the message to.

Note: You can insert an address from your Contacts address book by tapping **Address** on the Toolbar, or using the command on the **Edit** menu.

3. Type in the title of your message on the **Subject** line.
4. Type in your message at the bottom of the screen (under the subject).
 - You can use the commands on the **Edit** menu to copy, move and find text.
 - You can check the spelling in your message before saving it by tapping on the **Spell button** on the Toolbar or by using the command on the **Tools** menu.
5. You can send files with your email, e.g. a Word or Sheet document, by adding them as “attachments”. To do this, tap the **Attachments** button on the Toolbar and select **Add**. See ‘Attaching files to messages’ later.



Can I include text formatting or pictures in a message?

No. You can only use plain unformatted text in email messages, but you can attach files to the email containing formatted text and pictures.

Saving unfinished messages as drafts

If you don't have time to finish writing a message, you can save the message as a "draft" in your Local Draft folder. Draft messages are not sent when you connect to your Remote mailbox, and you can edit them as many times as you wish before you send them.

When you've finished writing a draft message, you need to move the message from the Draft folder into the Outbox so that you can send it the next time you connect.

- **To save a message as a draft:** tap the **Save to draft** button on the Toolbar, or select the command from the **File** menu.
- **To edit a draft email:** highlight the message in the Draft folder and tap on it or press Enter.
- **To save a draft message to the Outbox:** highlight the message in the Draft folder, then tap the **Save to outbox** button on the Toolbar, or use the command on the **File** menu.

Message editor

Recipients

Message text

04:16:35 pm 09/07/1999 Priority: High

To: mike.jackson@air-deals.com

CC: katrina.seabrook@air-deals.com

BCC:

Attachments:

Subject: Holiday Booking

Hi Mike,

I'd like to confirm my booking for the 25/10/99 (ref E2564).

Could you clarify for me if transfer charges are included in the price?
Also, is there the possibility of upgrading to fully inclusive at this hotel, and if so, at what cost?

If you can confirm these, I will send you a cheque for full payment.

Regards
Bill

Priority: High
Normal
Low

Email

Address
Attachments
Save as draft
Save to outbox
Spell
Print



Priority





Sending email

When you're ready to connect and send your email, make sure all the messages you want to send are in the Outbox folder.

Note: Make sure that your mobile phone or modem is connected to your Series 7.

To send email:

1. Move to the Outbox folder to view the messages you want to send.
2. Tap the **Send** button on the Toolbar, or select **Send from outbox** on the **Transfer** menu, then:
 - Select **All** to send all the messages in the Outbox.
 - Select **Selected** to send only the emails you have highlighted.
 - Select **Email** to send email messages only, i.e. if you don't wish to send fax or SMS messages waiting in the Outbox.



Outbox folder

Messages to be sent

Note: If you are not connected to the Internet, you will be shown details of the connection which your Series 7 will use. Make sure these settings are correct before proceeding. Once connected, your message(s) will be sent.

Email will send the messages from your Local mailbox to your Remote mailbox. Copies of emails that have been sent are placed in the Sent folder; whilst messages which couldn't be sent are left in the Outbox and displayed in *italics*.

Note: Delete messages you no longer require from the Sent folder to save disk space.



How do I send Outbox messages automatically when I connect?

If you want messages in the Outbox to be sent automatically when you make a connection, first select the name of your account from the **Account settings** commands on the **Tools** menu. Then move to the 'Outgoing' page for your account and tick the **Auto send on opening** box.

Receiving email

In order to receive your email, you first need to connect to your Remote mailbox to see your incoming messages. You can then select which messages to download to the Local Inbox folder on your Series 7.

Note: Make sure that your mobile phone or modem is connected to your Series 7.

To connect and receive your email:

1. Tap the **Open mailbox** button on the Toolbar and select the name of your account, or use the **Open** commands on the **Transfer** menu.

Note: If you are not connected to the Internet, you will be shown details of the connection which your Series 7 will use. Make sure these settings are correct before proceeding.

2. When you have connected to your mailbox, you can see all the messages it contains by tapping on the mailbox icon (with your account name shown next to it). The title and details of each message are displayed, with new messages displayed in **bold**.
3. To read the messages in your Remote mailbox, you must transfer (or 'download') them to the Local Inbox on your Series 7. Highlight the messages you want to read then:
 - To copy the message to your Local Inbox, tap the **Copy (Inbox)** button on the Toolbar, or select the command from the **Transfer** menu.
 - To move the message to your Local Inbox, tap the **Move to Inbox** button on the Toolbar or select the command from the **Transfer** menu.

Note: If you move messages from your Remote mailbox, the only copies of these messages will be in the Local Inbox on your Series 7.

- Select **Delete** from the **Edit** menu to delete any messages.

Note: If you delete messages in the Remote mailbox they will be lost unless you have first copied them to your Local Inbox.





Viewing an email

The messages you transfer from your Remote mailbox to your Local Inbox are displayed in the Folders view. Unread messages are displayed in **bold**. A paperclip symbol  indicates that the message has an attachment (see 'Attaching files to messages').

To view an email:

1. Select the message you want to read and tap on it or press Enter.
2. Once you've read the message you can:
 - Reply to or forward the message by using the **Reply/f'ward** button on the Toolbar or the commands on the **Message** menu.
 - Close the message by tapping the **Close** button on the Toolbar or by using the command on the **File** menu.

Replying to & forwarding emails

You can respond to an email whilst you are reading it, or if you have selected it in the Folders view.

To reply to or forward an email:

- Tap the **Reply/f'ward** button on the Toolbar, or use the commands on the **Message** menu, then select:
 - **Reply to sender**: to reply only to the sender of the original email.
 - **Reply to all addressees**: to reply to everyone who received the original email.
 - **Forward**: to forward a copy of the original email to someone else.

You can now type in your response in the "message editor". The original message text is included in your message below a 'Header'. You can change the message address(es), subject, or add an attachment in the same way as you would when writing a new message. See 'Writing an email' for more details.



Can I stop messages being included in my reply?

Yes. You can choose whether to retain the original message text in your response by using **Editor preferences** on the **Tools** menu in the message editor.

When you have finished writing:

- If you want to send the message the next time you connect, tap the **Save to outbox** button on the Toolbar.
- If you don't want to send the message yet, tap the **Save as draft** button on the Toolbar to save the message in the Draft folder.

Original author

04:42:56 pm 09/07/1999 Priority: Normal

From: Jane Philips <jane.philips@creativity.com>

CC:

BOC:

Attachments:  directions 55k

Subject: Re: Lunch Meeting

Jane,

Please see attached map showing you how to get there.
There's a car park at the back and it should only take you 15 minutes from M25.

See you on Friday.
Sue

Subject: Lunch Meeting

Sue,

It would be great to see you again.
Could you give me directions and an idea of how long it will take me to get there.

Subject: Lunch Meeting

Email

- Address
- Attachments
- Save as draft
- Save to Outlook
- Spell
- Print



Header separator





Attaching files to messages

You can send files with emails, e.g. a Word or Sheet document, by adding them as “attachments”.

To add an attachment to a message you are writing:

- Tap the **Attachments** button on the Toolbar and select **Add**. When you attach files to the message they are displayed on the **Attachments** line.

Messages which contain attachments are displayed by a paperclip symbol  in the Folders view. If you have received a message

containing an attachment, you can view the file or save a copy of the file to disk. You can view attached Microsoft Word documents as plain text files.

To view or save an attachment:

1. Open the message containing the file you want to view.
2. Select the attachment on the Attachment line, then tap the **Attachments** button and select:
 - **Open**: to view the attachment.
 - **Save as**: to save a copy of the file on your Series 7's disk.

Attached file

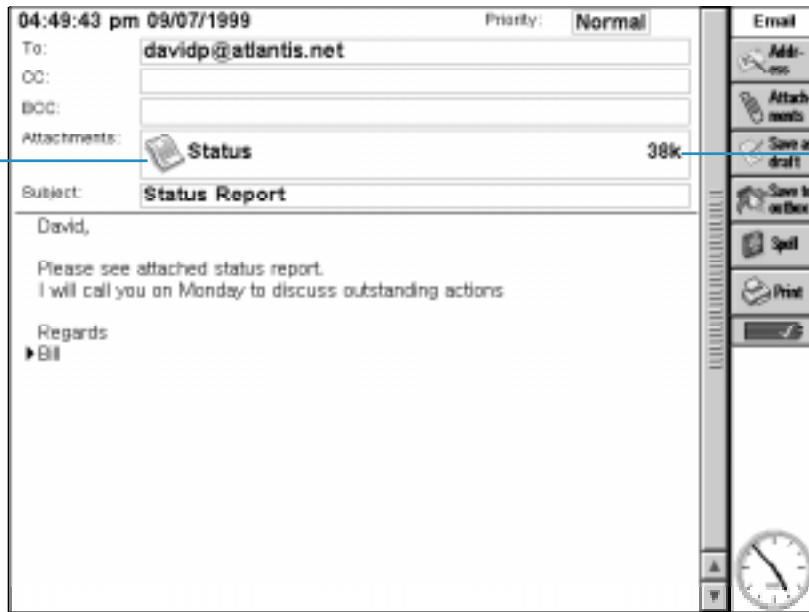

File size

Disconnecting

When you've finished using email on your Series 7, you can disconnect from your Remote mailbox by closing your email account.

To disconnect from your Remote mailbox:

- Tap the **Close mailbox** button on the Toolbar, or select your account name from the **Close** commands on the **Transfer** menu.

You can disconnect from your email account's Remote mailbox without disconnecting from the Internet, e.g. your "dial-up" connection. You may wish to stay connected to the Internet if you want to open a different mailbox or use the Web program.

To disconnect from the Internet:

- Select **Disconnect from Internet** on the **File** menu.



Important:

You should close any remote mailboxes you have open before disconnecting from the Internet.

Note: For details about setting up and using more than one email account, see 'To find out more'.

To find out more

For further information about using Email, see:

- **Setting Up Web and Email section:** a step-by-step guide on what you need to know about using email on your Series 7, and how to set up your machine to send and receive email messages.
- **Email on-line help:** detailed information about all the features of the Email program. To display on-line help about Email, open the Email program and select **Help on Email** from the **Tools** menu.
- **Email manual** (on PsiWin CD ROM): comprehensive information about the Email program, including: setting up your Series 7, sending and receiving email, fax and SMS messages, log-in scripting and using multiple email accounts.





CALC

Calc is the calculator program. It is split into two views: Desk and Scientific. The two calculators are distinct, so you can carry out two calculations at the same time without them affecting each other.

- The Desk view is a desktop calculator which produces a “till roll” output. Use this calculator for general arithmetical calculations, and those involving percentages.
- The Scientific view is a scientific calculator with 26 memories. Use this for more advanced calculations, including those that involve trigonometry or logarithms.

When you first use Calc, it displays the Desk calculator. Use the **Desk** and **Sci** buttons to move between the views, or select the view you want from the **View** menu.

Note: You may find the display suits your style of working better when it is “flipped”, i.e. when the left and right sides of the screen are swapped over. Just tap **Flip layout**, or use the command on the **View** menu.

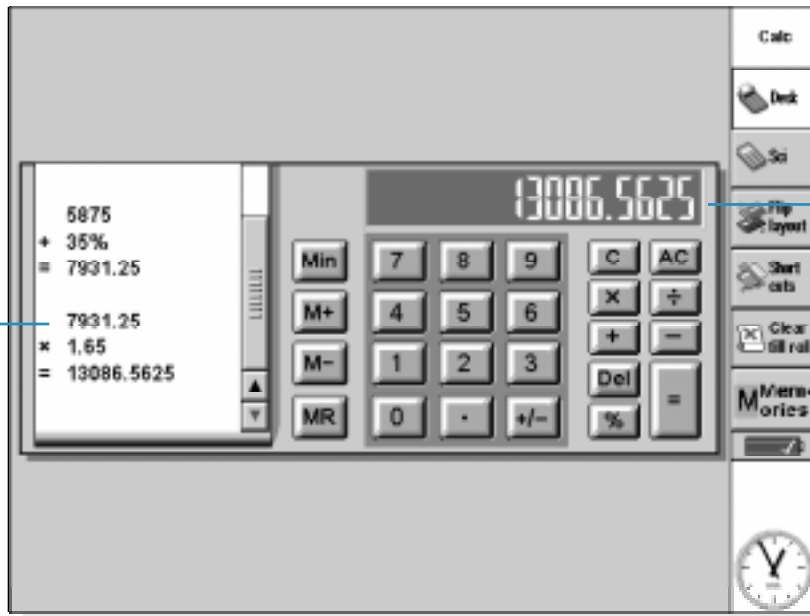

Till roll

Desk view

General calculations

To perform a calculation in the Desk calculator:

1. Enter your calculation using the number and operator buttons (+, -, × and ÷) on screen or the keyboard. There is no operator precedence in the Desk view: all calculations are performed as you type them in. So, $10 + 5 \times 3 = 45$, not 25.
2. Tap = or press Enter to get the result.
 - Use +/- or the m key to change the sign of a number.
 - Tap the **Shortcuts** button in the Toolbar to display a list of shortcut keypresses.
 - To clear the calculation line without ending the current calculation, press **C**.
 - To clear the calculation line and end the current calculation, tap **AC** or press Esc.

The till roll keeps a record of your calculations so that you can refer back to work you did earlier. The till roll scrollbar will appear when the calculations cover more than one page. To move around the till roll, use the scrollbar or the arrow keys. To clear the till roll, tap the **Clear tillroll** button on the Toolbar or use the command on the **Tools** menu.

You can switch to the embedded numeric keypad (orange print) by pressing Shift + Menu.

Using the memory

You can use the memory to store a value that you want to re-use, or to act as a “running total”. The **Memory** commands can be accessed from the **Memories** button on the Toolbar or the command on the **Tools** menu.

- **To store a number in the memory:** tap **Min** or select the **Save in** command while the number you want to store is in the calculation line. An 'M' will appear in the calculator display while there is a value stored in the memory.
- **To retrieve a number:** tap **MR** or select the **Recall** command.
- **To add the current number to the number in the memory:** tap **M+** or select the **Add to** command.
- **To subtract the current number from the number in the memory:** tap **M-** or select the **Subtract from** command.
- **To clear the memory:** tap **Min** while 0 is displayed in the calculation line, or select the **Clear** command.





Percentage calculations

Use % on the Desk calculator to perform percentage calculations.

- **To calculate 40% of 60:** enter 60×40 , then tap %.
- **To increase 60 by 40%:** enter $60 + 40$, then tap %.
- **To decrease 60 by 40%:** enter $60 - 40$, then tap %.
- **To calculate what % 60 is of 200:** enter $60 \div 200$, then tap %.
- **To find the number that 60 is 40% of:** enter $60 \div 40$, then tap %.

You can use a combination of the memory and the % facility for, say, tax calculations. If you have the rate of taxation stored in the memory, you can quickly add or deduct the tax from any number:

- **To add the tax to a number:** enter the number and tap +. Tap MR and then %.
- **To deduct the tax from a number:** repeat the above, using - instead of +.

Scientific calculations

To perform a calculation in the Scientific view:

1. Use the number, operator and function buttons to enter your calculation. Enter scientific functions in the order you would write them down. For example, tap log BEFORE entering the number you want to find the log of, but tap x^2 AFTER entering the number you want to square.
 2. Tap = or press Enter to get the result.
- Tap the Shortcuts button in the Toolbar to display a list of shortcut keypresses.
 - **To clear the calculator display:** tap AC or press Esc.
 - **To remove the item immediately to the left of the cursor:** press Del.

You can position the cursor anywhere on the calculation line using the pen or the arrow keys.

Operator precedence

Operator precedence in the Scientific view is as follows (highest first):

- Information in brackets.
- Functions which follow the value to which they refer, e.g. $x!$
- Powers.
- Implicit multiplication before a memory value, i.e. $30A$.
- Prefix functions which precede the value they refer to, e.g. \sin .
- Implicit multiplication before prefix function, such as $5\sin 30$, or before an open bracket, as in $4(4+5)$.
- Multiplication and division equal, calculated left to right.
- Addition and subtraction equal, calculated left to right (lowest).

See the Series 7 help for more about entering expressions and operator precedence in the Scientific calculator.

Scientific
or 'Sci' view

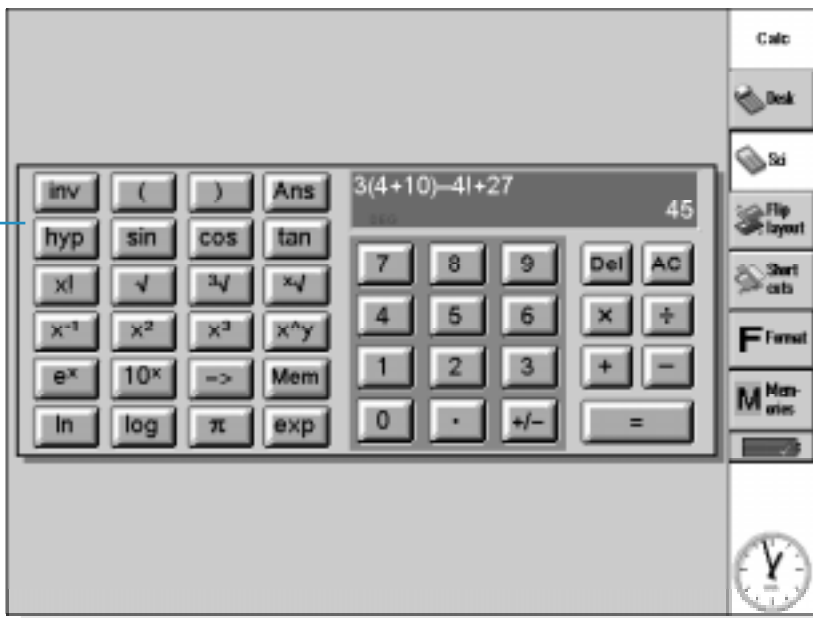



Re-using answers and calculations

In the Scientific view you can re-use the answer from your last calculation.

- **To insert the last answer at any point in a calculation:** tap the **Ans** button at the appropriate point. The calculator will insert 'Ans' in the calculation line, representing the last result.
- **To start a new expression with the last answer:** just enter the rest of the expression as though the answer was already written at the start. The calculator will prefix the expression with 'Ans'.

You can also re-use and edit calculations you have performed earlier. This can save time if you want to perform a new calculation which differs only slightly from a previous one.

- **To re-use a previous expression:** use the up and down keys, or the **Edit previous** and **Edit next** commands on the **Edit** menu, to display the last 10 calculations one by one on the calculation line. When you find the expression you want to re-use, change it if required and proceed as normal.

Note: The value of Ans used in a calculation will always be the value of the last calculation. If you re-use a calculation based on a value of Ans, the result will be calculated using the current value of Ans rather than the value at the time of the original calculation.

Using the memories

The Scientific calculator has 26 memories, labelled A through to Z. You can assign a value to each of these memories, and then incorporate the names into expressions.

To assign a value to a memory:

1. Enter the number to be stored. If the calculation line is displaying an unsolved expression, the stored value will be the **RESULT** of the expression.
2. Tap **->**, or select **Assign to** from the **Memories** button on the Toolbar or the command on the **Tools** menu.
3. Type the memory name. As memory names must be entered as a capital letter, you will probably need to hold down the shift key and type the letter key for the memory name.

Note: You can also assign a value to a memory by tapping the **Mem** button, highlighting the memory to use and then tapping the **Assign to** button in the dialog.

- **To display the contents of the memories:** tap the **Mem** button, or select **Show all** from the **Memories** commands on the **Tools** menu.
- **To use a stored number in a calculation:** type the capital letter corresponding to the memory at the appropriate point in the calculation. Alternatively, tap the **Mem** button to display the list of memories, highlight the memory you want and tap **Select**.

Note: You can assign values to the memories in any order you like, so use the names as a reminder of the information they contain. For example, use the T memory for a rate of taxation, Y for the rate of exchange into yen and so on.

Memory contents

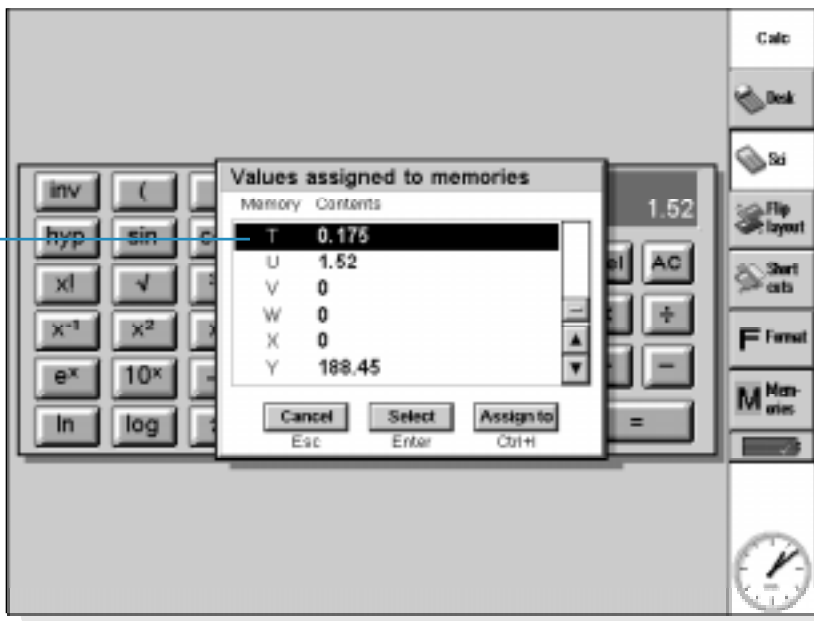



Powers, roots & reciprocals

You can calculate squares, cubes and powers using the buttons in the Scientific view.

- **To calculate the square of a number:** enter the number, tap x^2 , then press $=$.
- **To calculate the cube of a number:** enter the number, tap x^3 , then press $=$.
- **To calculate a number to a given power:** enter the number you want to raise to a given power. Tap x^y and enter the power. Press $=$.
- **To calculate the square root of a number:** tap $\sqrt{\quad}$, enter the number, then press $=$.
- **To calculate the cube root of a number:** tap $\sqrt[3]{\quad}$, enter the number, then press $=$.
- **To find the x root of a number:** enter the number of the root you want to find, e.g. 4 for the fourth root. Tap $x^{\sqrt{\quad}}$, and enter the number you want to find the x root of. Press $=$.
- **To calculate the reciprocal (1/x) of a number:** enter the number then tap x^{-1} and tap $=$.

Trigonometric functions

- **To calculate the sine, cosine or tangent of a number:** tap **sin**, **cos** or **tan**. Enter the number and press $=$.
- **To calculate the inverse sine, cosine or tangent of a number:** tap **inv** once, then tap **sin**, **cos** or **tan**. Enter the number and press $=$.
- **To calculate the hyperbolic sine, cosine or tangent of a number:** tap **hyp** once, then tap **sin**, **cos** or **tan**. Enter the number and press $=$.
- **To calculate the inverse hyperbolic sine, cosine or tangent of a number:** tap **hyp** and **inv** once each to depress them, then tap **sin**, **cos** or **tan**. Enter the number and press $=$.

Angle formats

The scientific calculator can express angles in degrees, radians and gradients (360 degrees = 2π radians = 400 gradients). The angle units you use will affect the outcome of trigonometric calculations.

- **To change the angle format:** select the **Formats** command from the **Tools** menu. Select the format you require.

You can also change the angle format by tapping on the abbreviation in the calculation line (e.g. DEG). If the result of a trigonometric calculation is being displayed when you do this, the result will automatically be re-evaluated.

Factorials

The **x!** button in the Scientific view calculates the factorial of a number. A factorial is the result of multiplying all the numbers from a given starting number down to one. So, the factorial of 4 (written as 4!) is $4 \times 3 \times 2 \times 1 = 24$.

Note: You can use factorials to find the number of ways things can be arranged. For example, if you want to find possible anagrams of a word with four letters, 4! shows that there are 24 ways these letters can be arranged.

- **To find the factorial of a number:** enter the number of which you want to find the factorial. Tap **x!** and tap **=**.

Logarithms

You can use the Scientific calculator to calculate logs and natural logs.

- **To calculate the log (base 10) of a number:** tap **log**, then enter the number. Press **=**.
- **To calculate the natural log (base e) of a number:** tap **ln**, then enter the number. Press **=**.
- **To calculate e to a given power:** tap **e^x**, then enter the value you want to find e to the power of. Press **=**.

Displaying numbers

The Scientific calculator can display numbers in the following formats:

- **Normal:** this is adequate for most calculations. Numbers are displayed in standard notation to 12 significant figures, with decimal places and an exponent as required.
- **Fixed:** this format always displays results with a specified number of decimal places, e.g. for currency calculations.
- **Scientific:** you may find this useful for dealing with very large or very small numbers. Numbers are displayed as a single digit to the left of the decimal point, a specified number of significant figures, and then an exponent.

To change the number format: select the command from the **Tools** menu. If you choose Fixed or Scientific, you can set the number of decimal places or significant figures to be displayed.

Exponent notation

You can express very large and very small numbers more succinctly using positive and negative exponents. For example, 57 200 000 can be expressed as 5.72E7.

To express a number as an exponent:

1. Enter the first part of the number, normally as a decimal fraction.
2. Tap **exp**. An 'E' will appear on the calculation line. To express a very small number, tap **+/-** to insert a minus sign before the second number.
3. Enter the number of decimal places that the first number needs to be moved to the left.





JOTTER

Use the Jotter program to jot down notes and information quickly, for example, when you are on the phone or in a meeting. You can keep each item of information as a separate entry, and search for text to find entries easily.

You may want to use a Jotter file as a quick and easy storage location for pieces of information, and then copy text to a more appropriate file or location later. Alternatively, you could have a number of Jotter files for different subjects or types of notes and keep the information for reference.

Adding a note

- When you first start Jotter, you can start typing a note straight away. You can type as much text as you like or use the **Paste** command on the **Edit** menu to insert text from other programs.
- If your Series 7 is connected to your PC, you can use CopyAnywhere in PsiWin to copy text on your PC and paste it straight into a Jotter entry. You can find out more about CopyAnywhere by looking at the PsiWin on-line help.

Split view

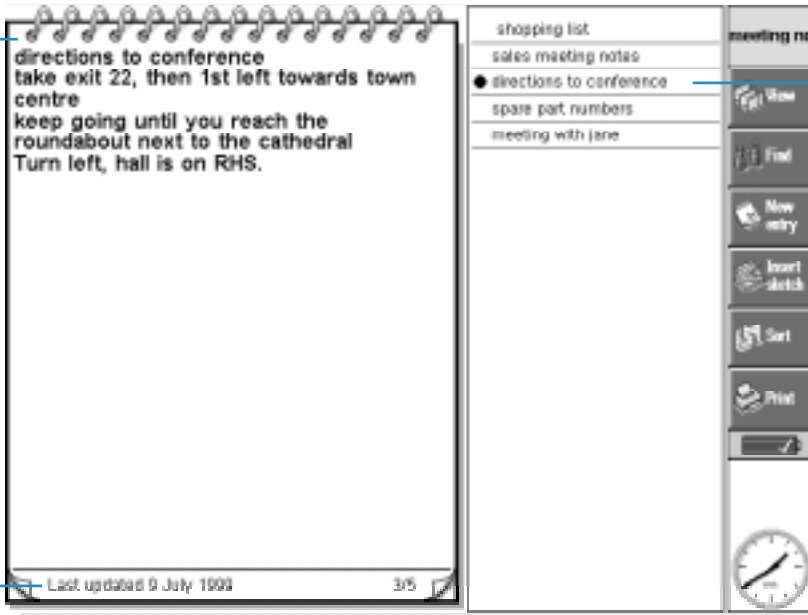

Selected entry

Entry date

- To insert special characters or symbols in the text use the **Special character** command on the **Insert** menu and select the character from the list.

Use the **View** button on the Toolbar to change between the Jotter views. Edit view displays one entry using the full width of the screen, List view displays a list of text from each entry, and Split view shows the list and the text of the current entry. You can add entries from any view.



Starting Jotter with a blank entry.

When you open a Jotter file, you will see the entry you were using the last time you opened the file. If you want to add an entry, you have to use the **New entry** command. To save time when you want to quickly type a note, you can set up Jotter so that it always starts with a blank entry. To do this, use **Entry preferences** from the **Tools** menu.

Formatting the text

- **To insert a bullet:** Move the cursor to the paragraph and select the **Bullet** command from the **Text** menu. To remove a bullet from a paragraph, move the cursor to the paragraph and select the command again to remove the tick.
- **To format text:** Highlight the text you wish to format and use the commands on the **Text** menu to change the font, size of the text, underline the text or make it bold or italic.





Inserting other information

To insert the date:

- Select **Date** from the **Insert** menu. Note that Jotter can display either the date that you created the entry, or the date it was last changed. See 'Customising Jotter' for more details.

To insert a sketch:

1. Select **Sketch** from the **Insert** menu, or tap the **Insert sketch** button on the Toolbar.
2. Draw the sketch, then tap the **Done** button to return to Jotter and insert the sketch.

Inserted sketch

The screenshot shows the Jotter app interface. On the left, a note titled "directions to conference" contains the following text: "take exit 22, then 1st left towards town centre", "keep going until you reach the roundabout next to the cathedral", and "Turn left, hall is on RHS." Below the text is a hand-drawn sketch of a road layout. The sketch shows a road starting from the bottom left, turning right, then left, and finally right again. A building labeled "conference hall" is shown at the end of the road. A road sign labeled "A77" is also visible. A blue arrow points from the text "Inserted sketch" to the sketch.

On the right, a toolbar is visible with the following buttons: "New", "Find", "New entry", "Insert sketch", "Set", "Print", and a clock icon. Below the toolbar is a list of notes: "shopping list", "sales meeting notes", "● directions to conference", "spare part numbers", and "meeting with jane".

At the bottom of the note, it says "Last updated 9 July 1999" and "3/5".

To insert other objects, i.e. a graph, table, text or a sound, select **Other object** from the **Insert** menu and then select the program you want to use. Create the information you want to insert then tap **Done** when you've finished.

- You can include Sheet information as a graph or table, so display the information as you want it to appear before tapping **Done**.
- To change the appearance of a Sheet or Sketch object, select **Format Object** from the **Object** commands on the **Edit** menu. You can change the size, crop the edges or just display the object as an icon. Note that Jotter can only display inserted sounds and Word objects as icons so you cannot change any format settings.
- If you wish to make changes to a sketch, graph or other object in a Jotter entry, highlight the object and press Enter. Change the object as required, then tap **Done** to return to Jotter and update the object.

Finding a note

If you need to find a particular entry, you can:

- **browse for the entry in the List or Split view.** To display text from the entries in a list, tap the **View** button on the Toolbar and select either **List** or **Split**. The List view may be useful if you can identify the entry from the first few words. The Split view shows the text in the current entry as well as the list.
- **search for text in the entry.** To do this, tap on the **Find** button on the Toolbar, or select the command from the **Edit** menu. Type the text you want to find, then press Enter to search all the entries and display the first entry that includes the text. Use **Next** and **Prev** to move between the entries in the search results. Tap **Done** to end the search and display all the entries again.

Deleting entries

If you don't want to keep a Jotter entry, select the entry and use **Delete entry** from the **Edit** menu to delete it. If you accidentally delete an entry, you can restore it by using **Undo delete entry** on the **Edit** menu.





Customising Jotter

You can change some aspects of how Jotter looks and works using the commands on the **Tools** menu.

- To display either the date you created an entry, or the date you last updated it, use **View preferences** in the Split view.
- You can display the list of entries in the Split view on the left or right, or change the proportion of the screen taken up by the entry and title list. To change these settings, move to the Split view and select **View preferences**.
- You can change the amount of information included in the list of entries in the List and Split view using the **Entry preferences** command. You can display as much of the text as will fit (with a comma marking different paragraphs) or just the first line of the entry. You may want to do this if you want to use the first line of the entry as a title.

Sorting entries

Jotter lists entries in the order in which you add them, with the newest entries at the end of the list. To sort them into alphabetical or date order:

1. Tap the **Sort** button on the Toolbar or select the command from the **Tools** menu.
2. Specify how you wish to sort the entries, e.g. alphabetically or by date.
3. Specify whether to sort the entries in ascending or descending order. For date ordering, ascending order means that Jotter lists the most recently added or updated entries last.

Jotter files

If you wish to start a new Jotter file, select **Create new file** on the **File** menu.

To combine the entries of two Jotter files, first open one of the files in Jotter. Select **Merge in** from the **More** commands on the **File** menu, then select the name of the file you want to merge.

Printing Jotter entries

You can print the current entry or all the entries in the current view using the **Printing** commands on the **File** menu or by tapping the **Print** button on the Toolbar.

- **To check the printer model:** select **Print setup**. If the printer model displayed is not the printer that you're using, use the **Printer** button to select the correct printer.
- **To set up the page for printing:** select **Page setup**.
- **To see how the information will look:** select **Print preview**.
- **To print:** select **Print**, then choose whether to print just the current entry or all the entries in the current view and tap **Print**.

Note: Refer to the instructions in the 'Printing' chapter to select a printer.





TIME

You can use the Time program to set, display and manage alarms, and to display a map of the world that gives you information on cities, times and dialling codes.

The Time program has two views: the Map view and Alarms view. To switch views, tap the **Map** or **Alarms** button on the Toolbar, or use the commands on the **View** menu.

Using alarms

You can use the Alarms view to set alarms that will ring even when your Series 7 is switched off, e.g. a 'repeating' wake-up alarm that will ring each day you work, and 'once only' alarms to remind you of appointments.

The Alarms view allows you to set up to 8 alarms, each up to 7 days ahead, and control their sounds.

Alarms

Home city

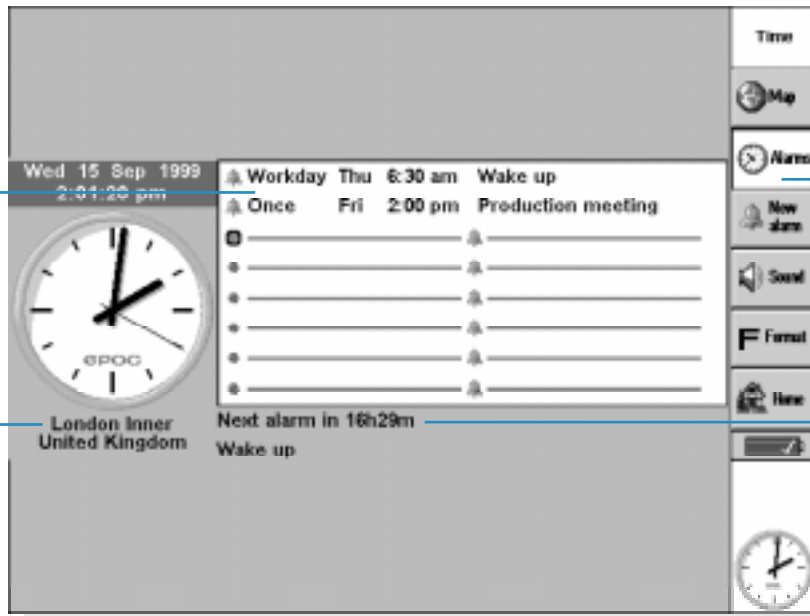

Alarms view

Next alarm

Setting an alarm

To set a new alarm, move to a blank line and then tap on it or press Enter (or just start typing the alarm text or the time you wish the alarm to ring). Alternatively, select the **New alarm** command from the **Edit** menu or Toolbar.

1. Set the time at which you wish the alarm to ring, and select one of the following alarm types:
 - 'Next 24 hours', if the alarm is to ring once at the specified time during the next 24 hours, or 'Once only', followed by a day, if you wish the alarm to ring once at the specified time more than 24 hours from now.
 - 'Daily', if you wish the alarm to ring every day of the week at the specified time, or 'Weekly', on a particular day, if you wish the alarm to ring at the specified time on that day every week.
 - 'Workdays', if you wish the alarm to ring at the specified time on each day you work. If your workdays are not Monday to Friday, select the **Workdays** command from the **Tools** menu.
2. Type the text you wish to be displayed when the alarm rings. This text will remain on screen until you respond to the alarm, so do not enter anything you do not wish others to see.
3. Select the required alarm sound, or 'Silent' if you wish the alarm to ring "silently" (you'll still see the alarm text on screen). To hear the selected sound now, press the **Test sound** button.

Note: A selection of alarm sounds is supplied with the Series 7, but you can also select any sound that you have created as an alarm sound yourself. See the 'Record' chapter for more details.

Responding to an alarm

When the time and date correspond to an alarm that has been set in Time or Agenda, the alarm rings and the alarm text is displayed on screen. The notify LED will flash to indicate that an alarm is ringing.

- **To clear the alarm:** press the **Clear** button or press Esc. If it is a once only alarm, it is removed. If it is a repeating alarm, it is automatically set to the next time it is due to ring.
- **To silence the alarm but leave the text displayed:** press the **Silence** button or press Enter. If the Series 7 is closed when an alarm rings, you can silence it by pressing the notify button.
- **To 'snooze' the alarm (i.e. to stop it from ringing) for 5 minutes:** press the **Snooze** button, the Spacebar or the notify button - each further press adds 5 minutes to the 'snooze' time, up to a maximum of one hour. You can carry on using the Series 7 while the alarm is 'snoozed'.





The alarm will snooze automatically for 5 minutes if you press a Program icon to move to another program, while an alarm is ringing. You don't have to press the **Snooze** button. After this time, the alarm will ring again.

Note: If you are recording a voice note or other sound when an alarm is due to ring, the alarm will be delayed until you have finished the recording.

Alarm warning

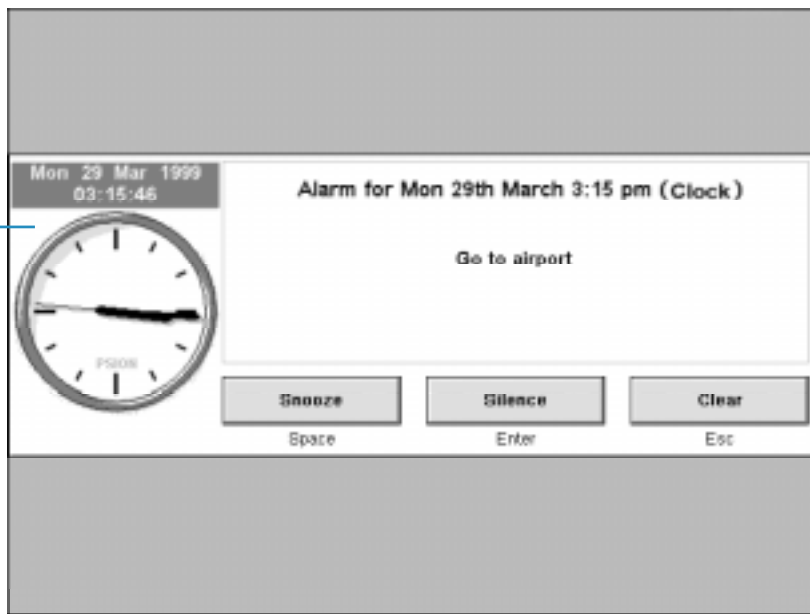

Changing & deleting alarms

If you wish to change any aspect of an alarm you have set, e.g. the time or the alarm text, move to the relevant line and press Enter or select the **Change alarm details** command from the **Edit** menu.

To remove an alarm, move to the relevant line, and press Del or select the command from the **Edit** menu. You can also delete any alarms that were set using the Time program from the **View next alarms** list. To delete one, highlight it and press the **Delete** button or key.

Note: When you delete a 'repeating' alarm, it is deleted for **all** days on which it is due to repeat.

Silencing alarms

If you wish to silence alarms for a particular period, e.g. the duration of a meeting or journey:

1. Tap the **Sound** setting at the bottom of the screen. Alternatively, select **Sound** from the Toolbar or **Tools** menu.
2. Set the alarm sound to 'Silent for' and specify the duration you wish alarms should be silenced. If you wish to silence alarm sounds indefinitely, set the alarm sound to off.

Note: When a 'silenced' alarm rings, the alarm text still appears on screen, and you need to respond to it as you would for an audible alarm.

- If you wish to stop an alarm from ringing without deleting it completely, e.g. if you wish to suspend your wake-up alarm while you are on holiday, move to the relevant line and select the **Disable alarm** command from the **Edit** menu. The alarm has a line drawn through it to show that it is no longer active.
- To make the alarm active again, move back to the relevant line and deselect **Disable alarm**.





Viewing alarms

The countdown to the next alarm, whether set in Time or Agenda, is given at the bottom of the screen. Use the **View next alarms** command on the **Edit** menu to view the alarms that are to ring in the future, and the **View past alarms** command to list the last 8 alarms to have been cleared (e.g. if you cancel an alarm, but need to be reminded of the alarm text).

Next alarms

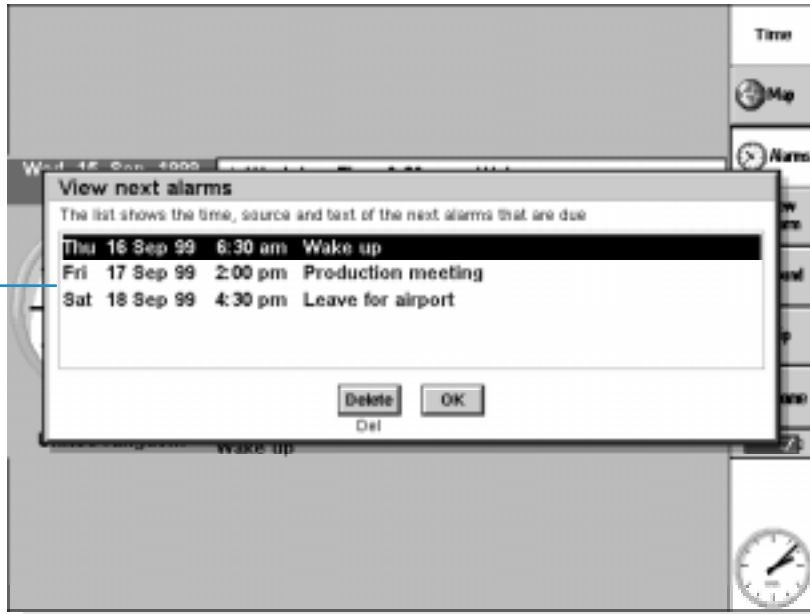

Using the map

You can use the Map view to display information for cities around the world. Set the city in which you are currently located as your 'Home' city, and then select other cities to find their time differences, dialling codes and distances from your Home city.

Important: In order for world information to be accurate, make sure you have defined your Home city, and the current time and date. Refer to the 'Getting started' chapter.

Selecting a country or city

To select a particular country or city, move to the country or city line at the bottom of the screen, and then:

- Start typing the name of the required country or city. Continue typing until the correct city and country combination is displayed, or use the right and left arrow keys to scroll through the available countries and cities in alphabetical order until you come to the one you require.

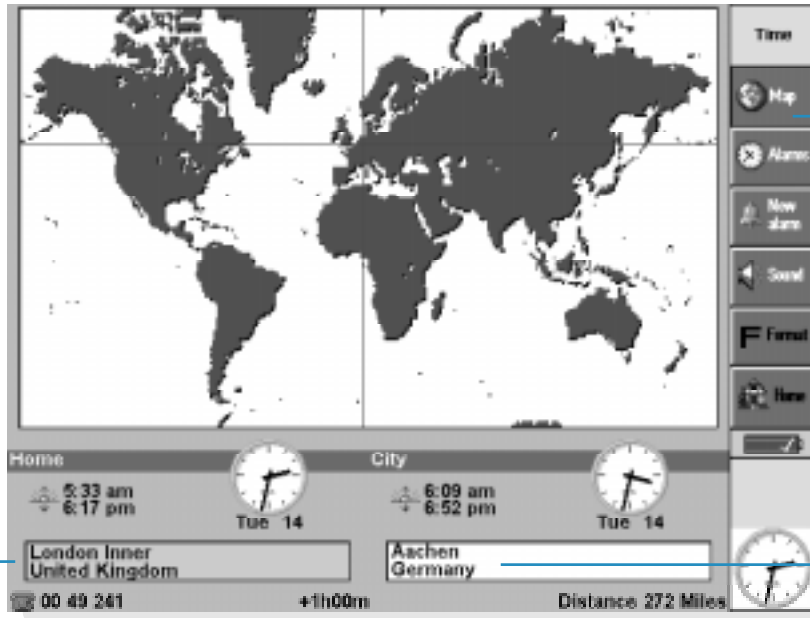

Home city

Map view

Selected city





- If you scroll through the countries, only the capital cities are listed. If you wish to view only the cities in one particular country, select the country, and then select the **Cities in current country** command from the **View** menu. To go back to displaying cities for all countries, reselect the command.

When you select a city, the cross hairs on the map move to the selected city, and information about the city appears at the bottom of the screen.

- The time difference between the Home city and selected city is displayed. This includes the difference in “GMT (Greenwich Mean Time) offsets” (the time zone difference) and includes a correction for summer time if necessary. For information about summer times, refer to ‘Setting summer time’ later.
- The code next to the telephone symbol at the bottom of the screen shows the digits needed to dial the selected city from the Home city.

Adding a town or city

If a place you require is not included in the Map view, you can add it:

1. Select the **Add city** command from the **Edit** menu.
2. Type the name of the city, its country, the latitude and longitude if known (this allows accurate distances and sunrise and sunset times to be calculated), the telephone area code, the GMT offset, and ‘Summer time zone’ (see ‘Setting summer time’ later in the chapter).
3. Position the intersection of the cross hairs on the town or city location, using the pen or the arrow keys.

You can select the command from the **Edit** menu to subsequently change any of the city details.

You can only delete a non-capital city that you have added to the map yourself. To do this, select it at the bottom of the screen and then select the appropriate command from the **Edit** menu.

Adding a country

If a country you deal with is not included in the Map view, you can add it:

1. Select the **Add country** command from the **Edit** menu.
2. Type the country's name, its national dialling code, its national dialling prefix (i.e. the digit(s) that needs to be dialled immediately prior to each city area code when telephoning from one city to another within the country) and its international dialling prefix.
3. Each country must have a capital city, and a dialog is automatically displayed for you to create one. Complete it as in the previous section.
4. Position the cross hairs on the capital city's location, using the pen or arrow keys.

You can select the commands on the **Edit** menu to change any of the country or capital city details.

Note: You can only delete a country that you have added to the map yourself. To do this, select it at the bottom of the screen and then select the appropriate command from the **Edit** menu.

Customising Time

To change the city clocks from 'analog' to 'digital', or vice-versa, tap the clock that is displayed next to either the Home or selected city. You can also change the Toolbar clock by tapping it.

The distance from the Home city to the selected city is given in the currently selected units (Kilometres, Miles or Nautical miles). These units can be changed using the command on the **View** menu.

Tap the **Format** button on the Toolbar or select the command from the **Tools** menu if you wish to change:

- The clock format, e.g. from 12 to 24 hours.
- The time separator (usually ':' as in '6:19 pm').
- The date format (e.g. 'Day Month Year' or 'Month Day Year').
- The date separator (e.g. '/' as in '01/03/99').

You can also set preferences for a standard alarm time if you tend to set alarms for the same time of day, or for a particular alarm sound to appear when you set a new alarm.





Setting summer time

If you are not interested in making use of world times, and are happy to use the **Time & date** command to change the time when clocks go forward or back, you can ignore this section.

However, if you travel or wish to be precise about world times, you should set your own time to 'winter time' (in the UK, this is GMT), and modify the 'summer time' setting when the clocks go forward or back.

You can also take into account the 'summer times' used in the different areas of the world. Most of the cities on the world map can be included in one of 3 basic areas, or "Summer time zones" - 'Europe', 'Southern' and 'Northern'. The approximate 'summer times' for these zones are:

Europe	End of March to end of October.
Northern	Early April to end of October.
Southern	Late October to end of February.

Each city on the map is associated with one of these zones, or with 'None'. To check what the Summer time zone is for a city, select the city in the Map view, and then select **Change city details** from the **Edit** menu.

When the clocks are due to go forward or back in the cities in a particular Summer time zone:

1. Select the **Summer times** command from the **Tools** menu.
2. Tick the time zone if it is changing to summer time; remove the tick if it is changing back to winter time. If your Home city is in that zone, then 'Home' is ticked automatically and the Series 7 clock will adjust accordingly.

The clocks, and sunrise and sunset times, for each of the cities associated with the 'Summer time zone' are changed.

Note: If the Home city has a 'Summer time zone' of 'None' because it is not in one of these 3 zones, but its clocks are due to change, you can change the Series 7 clock to 'summer time' by ticking 'Home'.

When you travel

Whenever you travel, reset your Home city to the town or city to which you have travelled. Then, provided that the city details and 'summer time' setting are correct on the Series 7 for the city to which you have travelled, the information in the Map view will automatically be accurate.





DATA

You can use Data to store information like a card index system, with a separate entry for each “card”.

When you first use Data, the “labels” (e.g. Subject:, Notes:, and so on) are designed so that you can start a “knowledgebase” of information straight away. You can use the standard labels to keep track of items of information about different subjects in one

file or in different files. For example, you may want to keep a database for notes about software products, another one for interesting Web sites, and another for restaurants you want to visit.

You can also create databases for other types of information by changing the labels to match the information you wish to enter. See ‘Customising the database’ later.

Labels

Card

The screenshot displays the Data application interface. On the left, a card view shows details for a 'Modem' entry: Item: Modem, Supplier: Intertrade Ltd, Cost (£): 69, Notes: 56k data only, and Fax order attached. On the right, a card browser lists various categories such as Modem, Monitor, CPU, FDD cable, HDD Cable, Cases, Graphics card, Motherboards, Mouse Mats, Keyboards, Printer, Print head, HDD, FDD, CD, Windows 95, Windows NT, Disks, ZIP drive, printer cable, mains lead - UK, and mains lead - eu. A vertical toolbar on the right side of the card browser contains buttons for parts, Cards, List, New entry, Edit entry, Sort, Print, and a clock icon. The bottom of the interface includes a Find: field, navigation buttons (Prev, Next), and a page indicator (1/24).

Card view

Card browser

Adding an entry

You can add entries in any order. You can sort them into alphabetical order later; see ‘Sorting entries’ later. To add an entry:

1. Tap the **New entry** button or select the command from the **Edit** menu.
2. Type the information in the appropriate boxes. If you don’t have any information for one of the labels, you can leave the box blank.
 - Tap on a label or use the Tab key to move between the boxes. Use the scroll bar to move to boxes which are not currently displayed.
3. While you’re typing, you can use the arrow keys to move the cursor around the text. Press Enter to start a new line of text.
 - Use the **Object** button to insert information from another program, e.g. a sketch. Select the program to use, then use the other program to create the “object”. Close the other program to return to Data.
 - 4. Use the **Save** button when you’ve finished typing an entry. This saves the information you’ve typed, and clears the dialog so that you can type another entry.
 - 5. Use the **Close** button when you have finished adding your entries.





Looking at entries

Data has two views you can use to look at entries. The Card view shows the information for each entry as a single page. A list of entries is shown in the Card browser next to the page; the currently displayed entry is marked with a bullet. The List view shows entries in a list, one entry per line, like a telephone directory.

- Tap the **Cards** button or the **List** button to move to a view, or select the commands on the **View** menu to switch between the views.

- In the Card view, tap on an entry from the Card browser to display the entry. You can also use the **Next** and **Prev** buttons or left and right arrow keys to move between entries.
- In the List view, use the up and down arrow keys to move through the list. You can use the scroll bars or the left and right arrow keys to see the other columns not currently shown.

Labels

Item	Supplier	Cost (\$)	Notes:
● Modem	Intertrade ltd	69	56k data only
Monitor	CXT	245	15" anti-glare
CPU	Intel	190	8 weeks leadtime
FDD cable	cabletex	1	260mm long
HDD Cable	Cabletex	1	240mm
Cases	Metalica	39	Tower and desk
Graphics card	RGB	45	1MB RAM
Motherboards	GM components	82	1M cache
Mouse Mats	GM components	23	blue, red, green, grey
Keyboards	Cherry	14	UK, FR, GER, IT
Printer	HP	169	model 3110
Print head	logica	43	for 3110
HDD	Seagate	154	4.3GB
FDD	Sony	17	
CD	Matsushita	89	x16
Windows 95	winhouse	39	CD and licence, simple
Windows NT	winhouse	43	CD, licence, simple g
Disks	Dataday	6	box of 10
ZIP drive	lomega	99	100mb
printer cable	cabletex	6	fully shielded
mains lead - UK	marbo	1	
mains lead - eu	marbo	1	
PSU	Delta	35	100-260v 145w

List view

Sorting entries

Entries are listed in the order you add them. To sort them into alphabetical order, tap the **Sort** button on the toolbar or select the command from the **Tools** menu. You can sort by any label and can also set the number of the labels to sort by, if you wish to sort by more than one label.

For example, in a database where you keep lists of your CDs, you could sort using the 'Artist' label, or the 'Title'. Or, you may wish to sort using both labels, 'Artist', then 'Title'.

Note: See 'Customising the database' for more about setting up a database with different labels.

Customising Data

To change the order of the labels in the Card view, and the columns in the List view, and change the way the labels are displayed:

1. Select the **Label preferences** or **Column preferences** command from the **Tools** menu.
2. Tap the label or column, or press the Spacebar to tick the label(s) or column(s) you wish to change, then use:
 - the **Move up** or **Move down** buttons to move them to a new position with respect to the other labels or columns.
 - the **Hide/Show** button to "hide" the label or column so that its information will not appear in the Card view or List view. You may wish to do this if the information is confidential and you do not wish the information to appear on screen in the Data views. Even if a label or column is hidden, you can still view and edit its information when you add or edit an entry.
 - the **Font** button to change the font size or type, or apply other formatting to the text.

You can also use the **View preferences** command in the Card view or List view to control how each view looks.

Finding an entry

You can find a particular entry, or a number of entries, simply by typing the text or characters that you want to find into the 'Find:' box. You can do this in either view.

- Start typing some text that you know is included in the entry you wish to find. Press Enter to display all the entries which contain the text.

Note: The information next to every label is searched, so you can find an entry by typing text that is beside a "hidden" label.

You may prefer to limit the labels that are searched, to make finding entries quicker:

- Select the **Find by label** command from the **Tools** menu, and tick the label(s) you want to use for searching. Add or remove a tick by pressing the Spacebar or by tapping the label with the pen.

Changing or deleting entries

To change the contents of an entry:

1. Select the entry by displaying it in the Card view, or by highlighting the line for the entry in the List view.
2. Tap the **Edit entry** button or select the command from the **Edit** menu.
3. Change the information as required, and press the **Save** button to save your changes.

To delete an entry:

1. Select the entry as described above.
2. Select the **Delete entry** command from the **Edit** menu.

Note: If you delete an entry by mistake, you can undo the damage by selecting the **Undo delete** command from the **Edit** menu.





Customising the database

You can use Data to store many different types of information. All you need to do is create a new file then change the labels in the file.

You can change the text in any label, or add or remove labels. If you wish, you can set up a new set of labels so that you can use a Data file for information other than names and addresses.

Important: It is best to set up the labels you want before you start to type in your entries.

To change the labels:

1. Select the **Change labels** command from the **Tools** menu.
2. Select a label and use the **Delete** button to remove it, or use the **Edit** button to change the existing text.

Note: When you delete a label, the information associated with it will be lost.

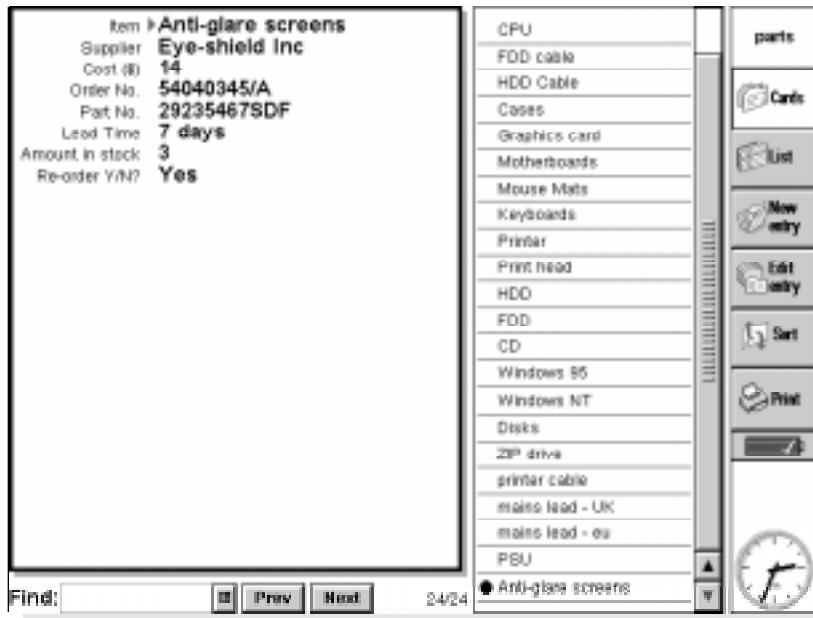

Adding labels

Use the **Change labels** command and the **Add** button to add labels to a database. You can add labels for different types of information, e.g. text, numbers, dates, Yes/No only, and specify the number of characters which can be typed for a text label.

You can also use the **Options** button to control how the label information is handled by the Data program, e.g. if the label should be checked when looking for telephone numbers when DTMF dialling is used, and how many characters are used when sorting the entries.

Important: It is not possible to change the data type for a label or the number of characters length of a text field after the label has been set. It is best to plan the database and label types first.

Printing Data entries

You can print all your Data entries, the current card, or choose a set of entries to print by typing a search clue.

- Before you print, refer to the instructions in the 'Printing' chapter to select a printer.

To print Data entries:

1. Display the entries to print by typing a search clue which the entries you want to print will contain. If you want to print all the entries, press Esc to make sure that all the entries are included.
2. Tap the **Print** button on the Toolbar or use the **Printing** command on the **File** menu:
 - Use the **Page setup** command to control the page size, margins, and add headers and footers. See the 'Printing' chapter for more details.
 - Use the **Print setup** command to specify how the entries will appear in the printed copy.
 - Use the **Print preview** command to display pages showing how your printed copy will look.
 - Use the **Print** command to print your entries.





SKETCH

You can use Sketch to produce pictures, including maps, freehand sketches, invitations etc.

You can start straight away, by drawing freehand with the pen on the screen. However, you may want to change the “pen” or “paper” before you begin to draw.

You can select:

- The “tool” to draw with. Each type of line or shape you can draw has a tool which you can select. When you start Sketch the Freehand drawing tool  is selected.
- The colour of the tool. The default drawing colour is black. To change the shade tap on a colour in the Toolbar, or select the **Colour palette tool** from the **Tools** menu.

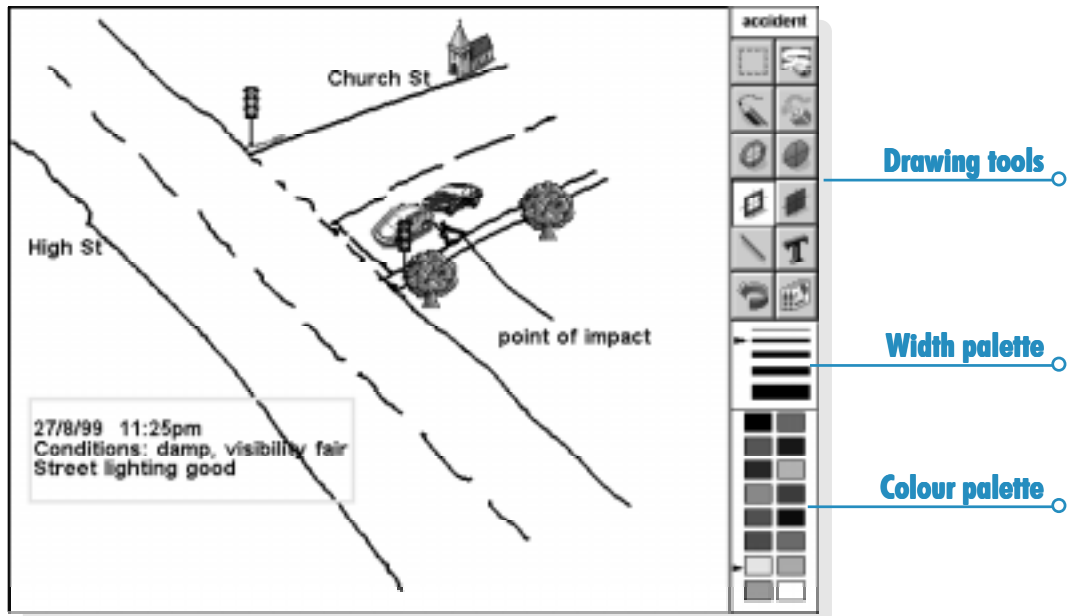







- The width of the line for the drawing tools and the erase tool. To change the width tap on a width in the tool bar, or select the **Width palette tool** from the **Tools** menu.
- The size of the sketch or the area on which you can draw. When you first start this is set to the same size as the screen. If you want to make it larger, select the **Resize sketch** command from the **Tools** menu and type in the new size. If the sketch is larger than the screen, you can use the scroll bars to move around the screen.



What are pixels?

You can specify some settings used in Sketch in “pixels”, e.g. the pen width. Pixels are dots on the page which are combined to make up a picture. For example, when you draw a line on the page Sketch treats it as a number of coloured pixels grouped together to form a line. If you later want to change the line, you have to edit each pixel.

Drawing sketches

- Tap on a button in the Toolbar to select a different drawing tool, or select a drawing tool from the **Tools** menu.
- Change the pen colour and width **before** starting to draw.
- Use the pen to draw, or hold down the Shift key and use the arrow keys.
- **To draw a straight line:** tap , or select the **Line** drawing tool from the **Tools** menu. To draw a vertical line, horizontal line or one at 45 degrees hold down the Ctrl key as you draw.
- **To draw either hollow or filled circles and ellipses:** tap  or , or select the **Oval** or **Filled oval** drawing tools from the **Tools** menu. You can draw a circle by holding down the Ctrl key as you draw.
- **To draw either hollow or coloured squares and rectangles:** tap  or , or select either the **Rectangle** or **Filled rectangle** drawing tools from the **Tools** menu. You can draw a square by holding down the Ctrl key as you draw.
- **To draw in a similar style to using a can of spray paint:** tap  or select the **Spray** drawing tool from the **Tools** menu.

Note: If you use the keyboard to draw, the drawing will start from the current cursor position. You might find it useful to show the cursor position so you can see where the drawing will start. You can use the commands on the **View** menu to view the cursor position as cross hairs, or as a message showing the number of pixels across (the X co-ordinate) and down (the Y co-ordinate).





Changing a sketch

You can change a sketch in two ways:

- by selecting an area and changing the selected area, e.g. moving, rotating, flipping or resizing it.
- by editing the pixels which make up the sketch.

To view the sketch in more detail, select the **Zoom in** command on the **View** menu. When you zoom in on a picture you can see the pixels comprising the picture and edit them individually.

Selecting & moving objects

- **To select part of the picture:** tap  or select the **Select area** command from the drawing tools on the **Tools** menu, then use the pen or arrow keys to drag a box over the area.
- **To select the whole picture:** select the **Select all** command from the **Edit** menu.
- **To resize an area:** select an area, then use the pen to drag one of the “handles” surrounding the area to a new position to enlarge or reduce the area. Use a handle at a corner to resize both the horizontal and vertical dimensions keeping the same proportions; the handle from the midpoint of a horizontal “edge” to resize only the vertical dimension, and the handle from the midpoint of a vertical edge to resize only the horizontal dimension.
- **To resize an area using the keyboard:** select the area then hold down the Shift key and use the arrow keys to move the cross hair of the cursor onto one of the handles surrounding the text. When the cursor is positioned directly over the handle, release the Shift key and use the arrow keys to resize the area. Press Enter to fix the selected area to the sketch.



- **To move an area:** select an area then tap inside the selected area with the pen and drag the area to the new position. You can also move the area using the arrow keys. Tap elsewhere press Enter to fix the selected area to the sketch.

You can turn selected areas over, and turn them round at angles of 90 degrees.

- **To flip part of a sketch:** select the area and then select either the **Flip horizontally** or **Flip vertically** command from the **Transform** menu.
- **To rotate part of a sketch:** select the area and then select the **Rotate** command from the **Transform** menu.



Transparency

When you move a selected area you can “overlay” it on top of an existing area of the sketch. You can specify whether the existing sketch shows through by making areas “transparent”.

- To make a selected area transparent either press the  button in the Toolbar, or ensure that the **Make transparent** command on the **Transform** menu is ticked.
- To make the selected area opaque (so that any underlying sketch does not show through), either press the  button in the Toolbar or remove the tick from the **Make transparent** command on the **Transform** menu.

Erasing & undoing

You can delete either all or part of your sketch, or undo up to the previous five actions you performed:

- To delete part of your sketch tap , or select the **Erase** drawing tool from the **Tools** menu. Use the pen or the arrow keys to delete part of the picture, starting from the cursor position.
- **To change the width of the Erase tool:** tap on a width in the Toolbar, or select the **Width** palette tool from the **Tools** menu. Change the width as required.
- **To delete the whole sketch:** select the **Delete all** command from the **Edit** menu.
- Tap , or select the **Undo** command from the **Edit** menu to remove the last action performed.

Changing colours

You can change the colour of an area by selecting a different colour and using the Freehand drawing tool to draw over the existing colour. You can select the **Zoom in** command from the **View** menu to view the picture in more detail, and change the colour of the individual pixels.

Use the **Reverse colour** command from the **Transform** menu to invert the colour of a selected area. For example, reversing the colour of an area makes any black areas white and vice versa.





Cutting out, cropping & re-sizing

You can cut out part of a picture by selecting the area to remove and selecting the **Cut** command from the **Edit** menu.

To remove unused space from around the edges of a sketch, select the **Crop** command from the **Tools** menu.

Adding text





To add text to your picture:

1. Tap , or select the **Insert text** command from the **Tools** menu.
2. Type in the text. You can format the text before you insert it using ,  or , and use the **Set Font** button to set the font type, size, colour and printing position of the text.
3. Press the **Insert** button to add the text to your picture.
4. The text is selected when you insert it into the sketch. You can move or resize it as usual.
5. Tap elsewhere on the screen or press Enter to fix the text onto the sketch.



Inserting “clipart”

Sketch includes a gallery of “clipart” pictures which you can insert into a drawing:

1. Tap , or select the **Clipart** command from the **Tools** menu. The clipart palette is displayed.
2. To select a piece of clipart either tap the picture, or use the arrow keys to select a picture and press Enter. You can rotate the clipart, for example, if you draw an arrow  then flip it vertically you get . Rotating  once provides .
3. The clipart is selected when you insert it into the sketch. You can move or resize it as usual.

4. Tap elsewhere on the screen or press Enter to fix the picture onto the sketch.

Printing sketches

The Printing commands are on the **File** menu.

- Before printing, it is useful to see what the sketch will look like on the page. To preview your picture use the **Print preview** command.
- To change the page size, orientation and margins, or add headers and footers to a sketch, use the **Page setup** command.
- When you are ready to print the picture, select the **Print** command.

Clipart

Inserted text

Transparency palette



Sketch files

When you use Sketch for the first time, you will see a blank screen. When you run Sketch at other times, the last sketch you created is automatically opened so that you can continue working.

- **To start a new sketch file:** use the command on the **File** menu.
- **To return to a different sketch file:** open the file using the command on the **File** menu.

The current file is saved each time you exit Sketch. You can also use the **More** commands on the **File** menu to:

- save the file at any other time using the **Save** command, or give it a different name using the **Save as** command.
- reject all changes made to a file since it was last saved using the command.



Creating “wallpaper”.

You can change the “wallpaper” that appears in the background on the System screen. You can use any picture that you draw or import into Sketch. See the ‘Customising your Series 7’ chapter for more information.

Zoom in to view pixels

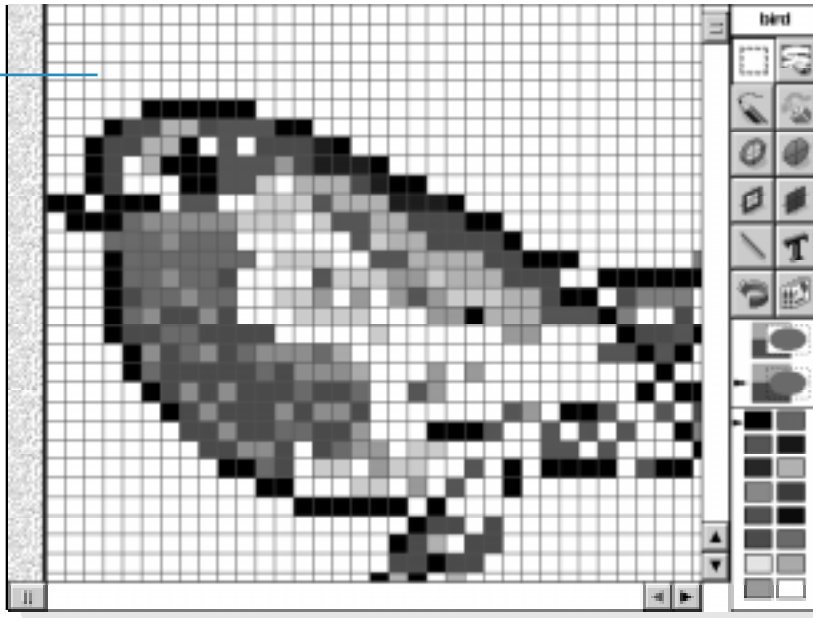
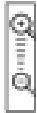

SPELL

You can use the Spell program to check the spelling of words, search for anagrams, find missing letters to help solve crossword clues and search for synonyms using the thesaurus.

You can also use the **Paste** command in Spell to insert words 'copied' in other programs into the box, and 'copy' the corrected word back into the other program. Refer to the 'Word' chapter for more information on checking the spelling of text in the Word program.

Spell-checking and correction

- **To check the spelling of a word:** type a word in the box and tap the **Spell** button, or select the **Spell check** command from the **Tools** menu.

If Spell finds the word you entered in its dictionary, it displays a message to tell you that the word is correct. If the word is not in the Spell dictionary, Spell searches for possible alternatives and lists them as they are found.

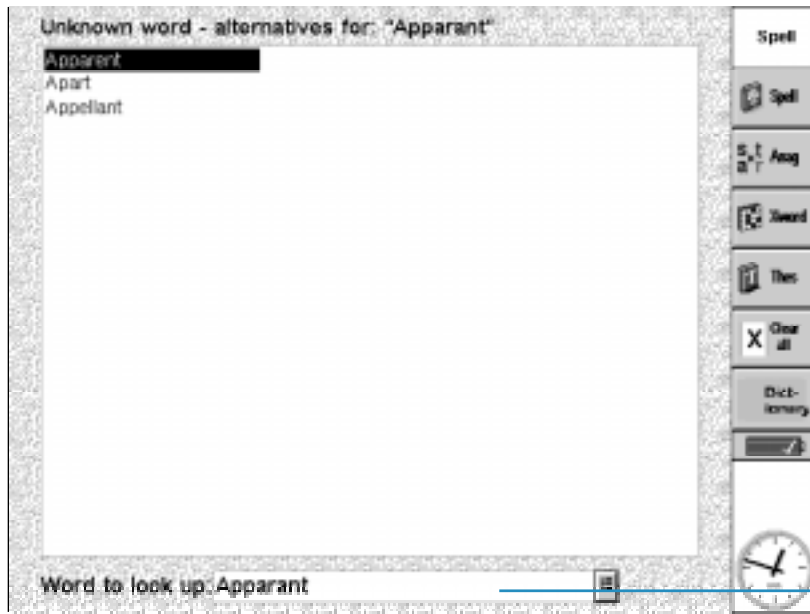

You can clear the display to remove the suggested solutions using the command on the **View** menu. You can also use the button to display the “history list” which contains the words you have used in this Spell session.

Using the thesaurus

You can use the thesaurus to search for synonyms, i.e. words which have the same or a similar meaning to a word you enter.

- **To use the thesaurus:** type the word in the box and tap the **Thes** button, or select the **Thesaurus** command from the **Tools** menu.

If there are suitable words, Spell lists them as they are found. Spell divides the synonyms into categories, each category relating to a different meaning of the entered word, with the main suggestions in bold. The words are separated into groups, e.g. adjectives, nouns, verbs etc.

You can select any word from the list of suggestions to look up again. To do this, either tap on a word to highlight it, and then tap again to select it, or use the arrow keys to highlight the word and press Enter. You can also select a word from the list, then use one of the Toolbar buttons straight away.

Solving anagrams

You can use Spell to search for anagrams of words or letters. An anagram is a word which has some or all of the letters as another word, arranged in a different order. For example, anagram suggestions for ‘angle’ could include ‘glean’, ‘angel’, ‘lane’ and ‘age’.

- **To search for possible anagrams of a word:** type the word in the box, tap the **Anag** button, or select the command from the **Tools** menu.

Spell lists possible anagrams as they are found. Spell lists the words in order of size, starting with the longest words it can find. If Spell doesn’t find any anagrams, it displays a message to tell you that no solutions were found.

Finding missing letters - Xword

To find missing letters to help solve crossword clues:

1. Type a word in the Word text box, entering '*' or '?' in place of the unknown letter(s). Enter '*' to search for several replacement letters, or '?' to search for one replacement letter.

For example, if you enter 'For*ed' suggestions include 'Forced', 'Foresighted', and 'Foraged', alternatively if you enter 'For?ed' the suggestions include 'Formed', 'Forked' and 'Forced'. You can enter '*' or '?' more than once when looking for missing letters, for example if you entered 'F?r?ed' the suggestions would include 'Forced' and 'Farmed'.

2. Tap the **Xword** button, or select the **Crossword** command from the **Tools** menu.

Crossword solutions



Search clue

Adding words to Spell

Spell has two dictionaries it uses when checking the spelling of words:

- The Spell dictionary, which contains the built-in words. The Spell dictionary is always used when checking a word.
- The Personal dictionary, which you can use to add other words that you want to keep in Spell, e.g. if you use a specialised vocabulary for your work.

You can use the Personal dictionary in addition to the Spell dictionary. You can view the contents of the Personal dictionary, and delete words if they are no longer required, or if you added them by mistake.

- **To use the personal dictionary as well as the Spell dictionary:** select the command from the **File** menu. This setting is saved when you close Spell, and also applies when spell checking words in other programs, e.g. when spell checking a Word document.
- **To add a word to the Personal dictionary:** type the word in the box then tap the **Dictionary** button on the Toolbar and select the **Add to** command or select the command from the **Personal dictionary** commands on the **File** menu.
- **To view the contents of the Personal dictionary:** tap the **Dictionary** button on the Toolbar then select the **Show contents** command or select the command from the **Personal dictionary** commands on the **File** menu. This makes it easier for you to remove unwanted words, especially if you can't remember all the words you have added to the Personal dictionary.
- **To delete a word from the Personal dictionary:** show the contents of the Personal dictionary (as described above), highlight the word you want to delete and select the command from **Personal dictionary** commands on the **File** menu.



RECORD

You can use the Record program to make sound recordings and create alarm sounds. You can record sounds and play back from any point in the sound.

Recording a sound

When you open the Record program you can begin to record right away. Simply place the machine so that the microphone is near the sound source and tap the **REC** button or press Enter.

Tap the **STOP** button, or press Esc to stop recording.

Note: The microphone is located to the right-hand side of the keyboard.

Playback point

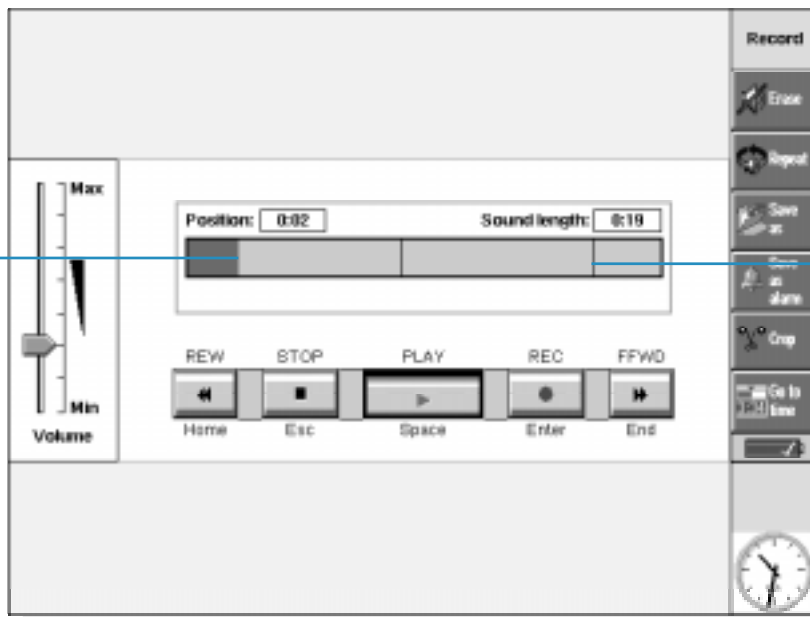

Start position of a recorded sound

- To record some more, tap **REC** or press Enter again. New sound is added to the end of the existing recording.
- To start a new file, select the command from the **File** menu. Type in the name before you begin recording.
- To save your file under a different name, tap the **Save as** button on the Toolbar or select the command from the **File** menu.
- To replace the ending of an existing recording, use the pen to drag the bar to the point where you want to begin recording (or select the **Go to time** button or the command from the **Play** menu and specify a start point in minutes and seconds), then select the **Record & replace** command from the **Record** menu.
- To erase the whole of the current recording, tap the **Erase** button on the Toolbar or select the **Erase all** command from the **Record** menu.

The maximum recording length depends on the amount of disk space available. While recording, a 'Time remaining' indicator shows how much more sound you could record if you wanted to use the available space. Record will not allow you to completely fill the disk, and will always leave 100K free so that you can use other programs.

Note: If an alarm is due to ring while you are recording or playing a sound, you may hear warning "ticks" and the alarm will be postponed until you finish the current action.

Playing sounds

To play back the entire sound file, tap the **PLAY** button, press the Spacebar, or select the command on the **Play** menu.

Note: The loudspeaker is located at the bottom of the machine, next to the backup battery door.

- To play back only part of a sound, use the pen to drag the cursor to the point where you want to begin playing (or select the **Go to time** command from the **Play** menu and enter the start position in minutes and seconds), then press **PLAY**. Playback begins from the selected point. To pause playback, press **PLAY** again.
- To adjust the volume, use the pen or the up and down arrow keys to move the volume fader to one of the volume settings, or set it to **Min** to turn off the sound completely.
- To play back a sound recording several times in succession, tap the **Repeat** button or select the command from the **Tools** menu and set the number of occurrences as appropriate.



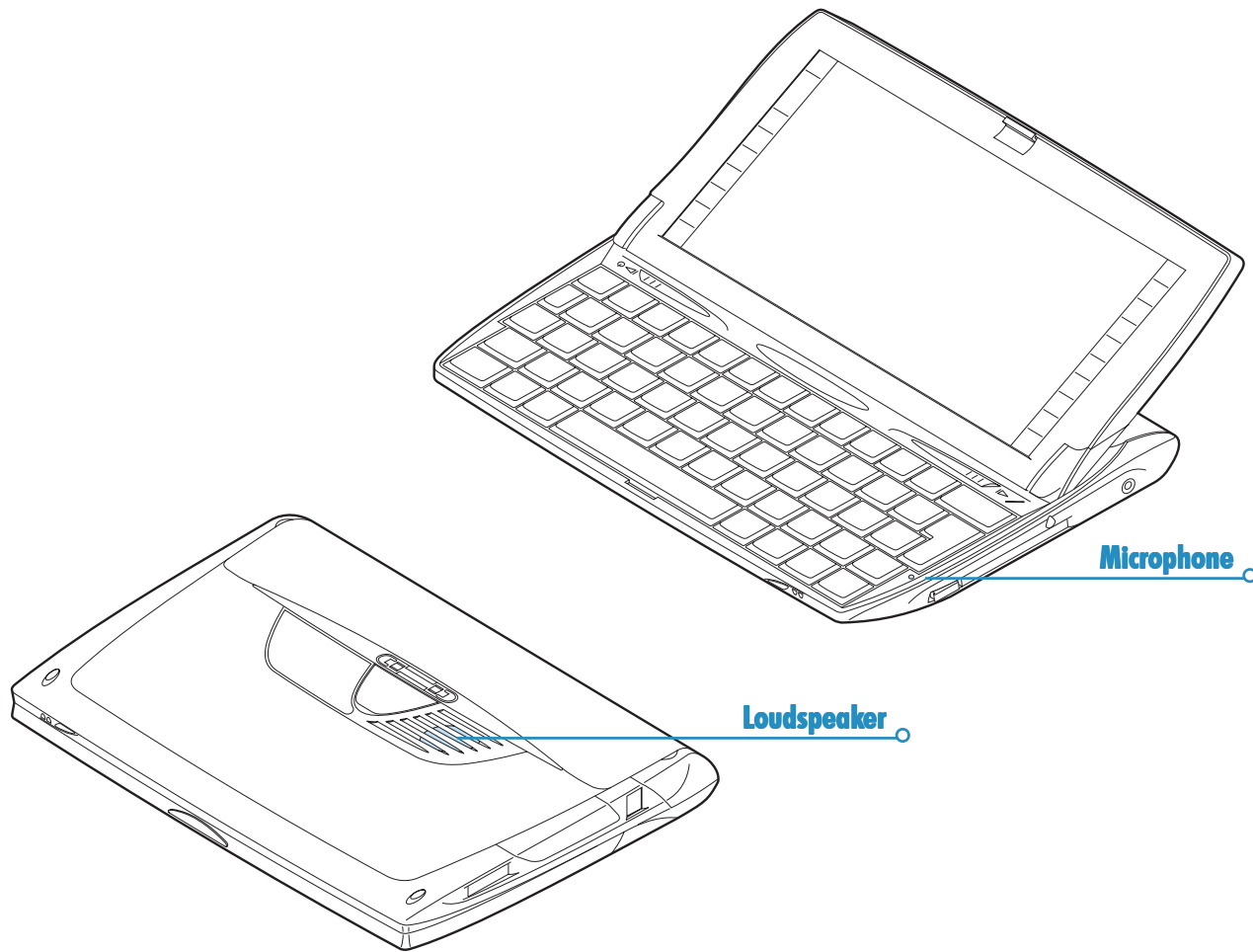

Microphone

Loudspeaker

File sizes and compression

Digital sound recordings can be very large. In order to save disk space a compression process is applied to Record files as they are being recorded.

- To save even more disk space use the **Compress sound** command on the **Tools** menu and select ADPCM (4 minutes per Mbyte) before starting to record the sound. This approximately halves the amount of space required. Search and skip functions may take slightly longer if a file is ADPCM compressed.





BOMBS- THE SERIES 7 GAME

Bombs is a game of speed and logical thinking. The object of the game is to discover and mark the position of all the concealed “bombs” in a grid of squares as quickly as possible, without accidentally uncovering any of the bombs.

You can select between easy, medium and hard skill levels, and 5 different grid sizes, using the **Skill level** button on the Toolbar. The harder the skill level, the more bombs are hidden in the grid. You can set the number of bombs by selecting the Custom skill level.

Number of adjacent bombs

Flagged square

The screenshot shows the Bombs game interface. The main grid is 10x10. The status bar at the bottom shows Time: 00:48, Bombs: 21, and Flags: 10. The toolbar on the right includes buttons for Game, Skill level, Best times, and New game. A clock icon is visible in the bottom right corner.

			1	1	1			1	2	2									
1	1	1	2	2	1			1	2	2									
2	2	1	2	2	1			1	1										
2	2	1	2	2	1			1	1										
1	1		2	3	3	2	1	1	1	2									
			1	3	3	3	2	1	1	1	2								
			1	3				2	2										
			1	3				1			2								

How to play

You can test a square by “stepping” on it. To do so:

- Highlight a square by tapping on it or by moving to it with the arrow keys. Then, to “step” on the square, tap on it again or press the Spacebar.

If you step on a square containing a bomb, you lose and the game is over. If there isn't a bomb under the square, stepping on it will reveal the number of bombs in the 8 adjacent squares. If you uncover a blank, the surrounding eight squares are revealed automatically because there cannot be any bombs under them.

If you suspect that a square conceals a bomb, mark it with a flag. To do so:

- Hold down the Shift key and tap on the square, or highlight the square then tap on the Flags counter or press Enter. Remove a flag in the same way.

If you know that all the bombs surrounding a numbered square have been marked with a flag, select the square and tap on it or press the Spacebar to uncover all the surrounding squares.

Scoring

Your score for the game is the time it takes to reveal all the bombs. The top two scores for each level, together with the name of the player, are kept in the **Best times** list.



PROGRAMMING

You can:

- Create and use programs on your Series 7 using the built-in programming language, OPL. Complete details of OPL command syntax is described in the OPL Programming Manual, available on the PsiWin CD ROM.

Creating & running OPL programs

1. Create the program in the Program editor program. Simply type in the OPL commands as required. You can edit text using the menu commands in the Program editor, which work in the same way as the commands in the Word processor, e.g. cut, copy, find.

Note: Text formatting will be applied to all the text in the file.

```
PROC exchange:
  LOCAL pounds, rate
  AT 1,4
  PRINT "How many Pounds Sterling?"
  INPUT pounds :REM value from keyboard
  PRINT "Exchange rate (£ to US$)?"
  INPUT rate :REM value from keyboard
  PRINT "=" ,pounds*rate, " US Dollars"
  GET
END
```

Program

Run

Find

Find next

Last error

Run

Go to



2. Tap the **Tran** button on the Toolbar or use the command on the **Tools** menu to translate the file into a program you can run on the Series 7.

If an error is found during translation, the cursor is positioned at the point in the program where the error is found and an error message is displayed. Refer to the OPL Programming Manual for details of error messages.

3. Once the program has been translated without errors, you can run it.

The translated (executable) file will be given the same filename as the source file, but with the extension `.OPO`. To run the program from the System screen, highlight it and then tap on it, or press Enter.





PSIWIN

This section gives you a quick introduction to PsiWin, and helps you to start using the program straight away. It shows you how to:

- connect your Series 7 to your PC.
- look at and copy files between your Series 7 and PC.
- make your first backup.
- find help on a particular subject.

PsiWin can be used for many more tasks, such as printing, archiving, installing programs on your Series 7 and synchronizing your Series 7 with a PC scheduler. The PsiWin on-line Help explains how to use all of the program's features. See later in this section for tips on using the help system to quickly find the information you need.

Installing PsiWin

Insert the PsiWin CD ROM into your PC's CD ROM drive to start the Installation Wizard. Follow the instructions in the Installation Wizard to install PsiWin or additional programs from the CD ROM.

Run the PsiWin setup file if you need to start the Installation Wizard manually, e.g. if you wish to install PsiWin from a networked CD ROM drive. To do this, select the **Run** option from the **Start** menu. Select **Browse** to enter the path to the file **Setup.exe** on the PsiWin CD ROM.

Note: If you can't install PsiWin from the CD ROM, visit our web site at www.pSION.com for more information, or contact your nearest Psion distributor.

Where can I find PsiWin?

Finding PsiWin

PsiWin installs a number of menu items, shortcuts and icons in your Windows environment.

- You can access all of PsiWin's features as well as the on-line Help and this user guide from the **Start** menu, by selecting **Start** → **Programs** → **PsiWin 2.x**.
- The **My Psion** icon on your Desktop is similar to the **My Computer** icon. Double-click on **My Psion** to display the files on your Series 7. Right-click on the **My Psion** icon to display a menu of PsiWin options.

Tip: You can change various PsiWin settings by right-clicking on My Psion and selecting Properties.

Note: The My Psion icon is also displayed in Windows Explorer with **My Computer**.

- The **Psion Backup** icon on your Desktop is used to back up files on your Series 7 to your PC. See the section on backing up your Series 7 later in this guide.
- The **Psion Synchronizer** icon on your Desktop is used to synchronize your Series 7 with PC schedulers such as Microsoft Outlook or Lotus Organizer.
- The **Connection** icon placed on the Taskbar (next to the clock) shows when your Series 7 is connected to the PC. You can right-click on the **Connection** icon to display a menu of PsiWin options.



My Psion



Psion Backup



Psion Synchronizer



There is often more than one way to access a particular feature in PsiWin, e.g. via the **My Psion** icon, the Menubar, or by right-clicking on an icon or file. This guide describes only the most straightforward methods of using PsiWin to help you get started. See the on-line Help for more information about other ways of using PsiWin, and setting up PsiWin to suit the way you work.

Getting help

Where can I find more help?

PsiWin includes comprehensive on-line Help which describes all of the application's features and functionality. Please consult the on-line Help for further information or guidance on using PsiWin.



You can display the help topics by:

- Selecting **Start** → **Programs** → **PsiWin 2.x** → **PsiWin Help**.
- Selecting the **My Psion** icon in Explorer and pressing the **F1** key.
- Double-clicking on **My Psion** and selecting **Help** → **Help Topics** from the Menubar.

Tip: You can display help for a particular task or dialog by pressing the **F1** key or clicking on the **Help** button.

Tips on using PsiWin help

From the **Help Topics** window, you can find the information you require as follows:

- From the Contents page you can select a topic from a structured list, e.g. how to perform a particular task, or troubleshooting information about how to solve a problem. To find the topic you want, double-click on the topic folders  to find the general area of interest, and then choose the topic  you want to display.
- From the Index page you can find the topic you want by entering any word linked to the subject, such as 'backup' to find topics containing information about how to back up your Series 7.
- From the Find page you can search for an exact word or phrase contained within a topic, such as 'serial port' to find all the topics in the on-line Help containing this phrase.

Tip: To provide further assistance, help topics may also include a **Related Topics** button  providing links to other help topics covering similar subjects.





Getting connected

Connecting the cable

As your Series 7 can communicate with various devices, you need to make sure that the communications link setting on your Series 7 is set correctly to communicate with your PC using PsiWin.

- Move to the System screen. Select **link to desktop** from the **Tools** menu and select the cable setting.

The cable is used by your Series 7 and PC to communicate. To connect the cable:

1. Locate the **COM** port (or **serial** port) on your PC, usually found at the rear of your computer. Insert the larger connector on the cable into the port on your PC.
2. Locate the serial port on your Series 7 and insert the smaller connector into the port.

Note: If you have difficulty connecting the cable to your Series 7, you may be attempting to insert the connector upside down. You should not have to apply force when inserting the connector into the port on your Series 7.

Further help: See the on-line Help for more details on how to connect your PC and Series 7, and troubleshooting information to help you solve any problems.

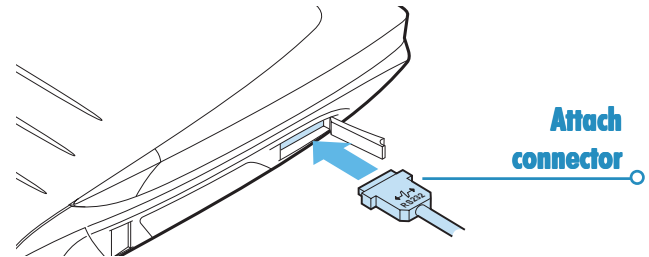
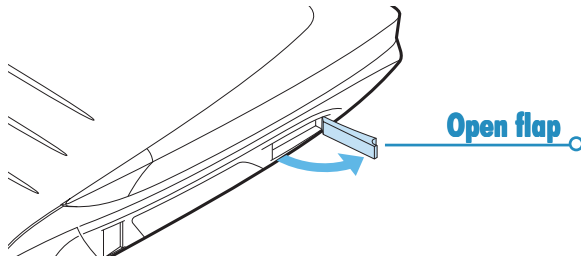

Selecting a COM port

PsiWin will search all your PC's COM (or serial) ports to detect your Series 7. When using peripherals such as modems (including internal modems) which use other COM ports on your PC, it is a good idea to set up PsiWin so that it does not search these ports. To do this:

1. Right-click on **My Psion** and select **Properties** from the menu.
2. Move to the **Connections** screen on the **My Psion Properties** dialog.
3. In the **Settings** list, uncheck any boxes for COM ports used by other devices. Make sure that you check the boxes for any ports you might use to connect a Psion.

Further help: See the on-line Help for more information on selecting which COM port to use.

Connecting with PsiWin

When you have connected the cable, PsiWin will automatically establish a connection between your PC and Series 7. You can tell if your Psion is connected by glancing at the **Connection** icon on the Taskbar (next to the clock).



Your PC is connected to the Psion. When a connection is made, the icon will appear as a curved line, which changes to a 'moving' curved line when the PC and Psion are communicating.



Your PC has not detected the Psion. This icon is displayed if the Psion is not connected, has been switched off, or if you have selected the **Disconnect** option from the **My Psion** or **Connection** icon menus.

Further help: See the on-line Help for more information on how to connect and disconnect a Psion.



Connecting for the first time

When you connect to your PC for the first time, you will be asked to enter a name to identify your Series 7.

1. A dialog will appear saying that a new Psion has been detected. Select the option to add a name for your Psion and then select **OK**.
2. Enter a name for your Series 7 and select **OK**.

Important: You must choose a different name for each Psion you connect to your PC. PsiWin uses the name you enter to identify information and backup files specific to each Psion.

Note: For Psion Series 3mx/3c/3a and Siena computers, PsiWin recognises the computer which has been connected by checking the owner information you have entered on the Psion. If you connect more than one Series 3mx/3c/3a or Siena to your PC, make sure that each Psion contains different owner information.

Further help: See the on-line Help for more information about connecting to your PC when using more than one Psion.

Working with your files

Looking at files on your Series 7

Using **My Psion** and Windows Explorer, you can open, move, copy and delete files stored on your Series 7 from your PC.

- Double-click on the **My Psion** icon on your Desktop. The **My Psion** window opens, displaying icons for your Series 7's internal drive(s) and other PsiWin features and settings.
- Double-click on a drive icon to display the files and folders on the drive.

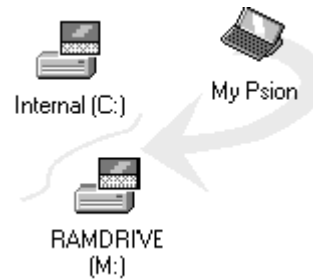

How to copy a file

Using Windows Explorer, you can copy files between your PC and Series 7 in the same way you would copy files to a floppy disk, or another PC on a network. PsiWin can convert files as they are copied so that you can open them on the other computer straight away.

1. Select **Programs** → **Windows Explorer** from the **Start** menu to open Windows Explorer.
2. Double-click on **My Psion** to display your Series 7's internal drive(s). Double-click on a drive icon to display its contents, then browse for the file you wish to copy.
3. Click on the file you wish to copy and select **Edit** → **Copy** from the Menubar.
4. Open the folder on your PC where you wish to copy the file and select **Edit** **Paste** from the Menubar.



Tip: You can also copy the file by clicking on the file icon and dragging it to the folder on your PC.

5. As PsiWin copies the file, a dialog box appears in which you can select the type of file you wish to use on the other computer.



6. The dialog suggests a suitable file type for the converted file, e.g. Excel 5.0/95 for a Psion Sheet file, or Word 6.0/95 for a Psion Word file. Select an alternative type if you use a different file type on your PC.
7. Select the **Convert** button to copy the file from your Series 7 to the PC and automatically convert it into the chosen file type.

Tip: You can select the Help button for more detailed help on the features of this dialog box.

You can use Windows Explorer to manage files and folders stored on your Series 7 in the same way as you can on your PC's drives.

Warning: When you delete a file on your Series 7 from your PC it is permanently removed from the Series 7's drive. The file cannot be retrieved from the Windows Recycle Bin, which only stores files deleted from your PC's drives.

Further help: See the on-line Help for more information on how to manage files, folders and disks.





Opening Psion files from your PC

You can open a file on your Series 7 using a PC application without first having to copy it to your PC drive. You can edit the file on your PC and then save it back to your Series 7 when you have finished.

1. To open a file from **Windows Explorer**, double-click on the file icon or press **Enter**. A dialog box appears in which you can select the type of file you wish to use on your PC.
2. Select the file type suitable for the application you will use to edit the file on your PC.
3. Click on the **Convert** button to copy the file and convert it to the chosen PC file type. PsiWin opens the converted file using the PC application associated with the file type, e.g. **Paint** for a Bitmap Image (*.bmp) file, or **Notepad** for a Text (*.txt) file.

When you save the file within the PC application, PsiWin saves the edited file back to your Series 7. A dialog box appears which allows you to select the file type for the edited file. Select the appropriate file type for your Series 7, and then select **Convert** to copy the file back to your Series 7. PsiWin makes a backup copy of the original file which is renamed with a '.bak' suffix, e.g. a file named 'Document' is backed up as 'Document.bak'.

Tip: Don't delete the backup version of the file from your Series 7 until you are sure you want to use the edited version instead.

Further help: See the on-line Help for more information on how to open Psion files on your PC.

Backing up your Series 7

Performing your first backup

You can use PsiWin to back up all the files stored on your Series 7 to your PC. Keeping backups of your Series 7 files on your PC means that you have a separate copy of all your work which can be restored to your Series 7. For example, you can restore backed up files to your Series 7 if you accidentally delete a file, wish to revert back to an older version of a file, or need to restore files if you forget to change the batteries.

To make a backup:

1. Double-click on the **Psion Backup** icon on the Desktop.
2. In the **Psion Backup** dialog, select the drive(s) on your Series 7 you wish to back up.
3. Click **Back Up** to start backing up the files on your Series 7. PsiWin displays a progress window showing how long the backup will take and will inform you when it has completed.

Further help: See the on-line Help for more information on how to back up and restore your Psion files.

Scheduling regular backups

You can set PsiWin to make automatic backups at regular intervals so you do not need to remember to back up your Series 7. It is a good idea to schedule automatic backups because it means you will always have up to date copies of your Series 7's files. To do this:

1. Right-click on **My Psion** and select **Properties**.
2. Move to the **Backup** tab.
3. Click on **Perform automatic backup** and select how often you wish to backup your Series 7.

Further help: See the on-line Help for more information on how to schedule regular automatic backups.

Synchronizing your Series 7

What is synchronization?

You can use synchronization to manage information which you wish to keep up to date on both your PC and Series 7, such as agenda appointments or an address book. When you synchronize, PsiWin checks the information in your PC scheduler with the matching Agenda or Data file on your Series 7, and then updates the files on both your PC and Series 7 to include the new information. Some examples of synchronization are:

- if you add a new appointment in your Series 7 Agenda, the date, time and notes for the entry will be copied to your PC scheduler.
- if you change a phone number in your PC scheduler, it will be amended in your Series 7's address book.
- if you enter overlapping appointments in your PC and Series 7 agendas, PsiWin will warn you of the conflict.

Many people will just use one synchronization task to keep their Series 7 information in step with their PC information.

Synchronization tasks can be used in a number of other ways, for example:

- You and other colleagues could synchronize their work Agendas with the same master scheduler on a networked PC.
- You may have a work Agenda synchronizing with a network installation of Organizer at the office, and a personal Agenda synchronizing with Schedule+ on your PC at home.

Further help: See the on-line Help for more information on how to synchronize your Series 7 with a PC scheduler.





PRINTING

You can print from most of the programs on the Series 7, including Data, Agenda, Word, Contacts, Sheet, Sketch and Program.

To print, you need one of the following:

- A printer which is IrDA Infrared compatible, if you wish to print files using Infrared.
- PsiWin installed on your PC, if you wish to print files via a PC.
- A Parallel Printer Link to connect to a parallel printer.
- The Docking cable and a Serial Printer Converter to connect to a serial printer.

Before you start printing, you need to specify:

- the method by which you are going to print.
- the “printer driver” for the printer you wish to use.

Setting up the printer

You can select the “standard” printer you normally use to print out files on the Series 7 from the System screen. The printer you select in the System screen is used for all programs unless you select a different printer from within a program, to use for that program only.

- **To select the standard printer:** tap the **Control panel** button on the Toolbar, or select the **Control panel** command from the **Tools** menu. Select the Printer icon, and select the printer model.
- **To select a different printer to use for an individual program:** open the program for which you want to change from the standard printer. Select the **Print setup** command from the **Printing** commands on the **File** menu, and press the **Printer** button to change the printer model and/or port.

Printing using Infrared

You can print directly from the Series 7 to any Infrared capable (IrDA) printer. To set up the Series 7:

1. Select the Printer icon from the Control panel in the System screen, or the **Print setup** command from the **Printing** commands on the **File** menu.
2. If necessary, press the **Printer** button. Select the printer model and select 'Infrared' as the method via which you want to print.
3. If you want, check the layout of the document using **Print preview**, then select the **Print** command from the **Printing** commands on the **File** menu.
4. Enter the range of pages and number of copies.
5. Point the Series 7 at the printer, making sure that the Series 7 and printer are no more than one metre apart, and press **Print**.

Printing to a parallel printer

You can use a Parallel Printer Link to connect the Series 7 directly to a parallel printer.

To do this:

1. Select the Printer icon from the Control panel in the System screen, or the **Print setup** command from the **Printing** commands on the **File** menu.
2. If necessary, press the **Printer** button. Select the printer model and select 'Parallel port' as the method via which you want to print.

Your Series 7 is now ready to print directly to a parallel printer. Refer to the documentation accompanying the Parallel Printer Link for more information on connecting it to your Series 7.





Printing to a serial printer

You can print to a serial printer using the Docking cable supplied and a Serial Printer Converter to connect to the printer. To set up your Series 7 to print via a serial printer:

1. Select the Printer icon from the Control panel in the System screen, or the **Print setup** command from the printing commands on the **File** menu in the program you want to print from.
2. If necessary, press the **Printer** button. Select the printer model and select 'Serial port' as the method via which you want to print.

You can change the settings for the serial port and handshaking by pressing the **Settings** button.

Using PsiWin to print via a PC

You can use PsiWin to connect your Series 7 to a PC using the Docking cable. You can then print files from your Series 7 to almost any of the printers installed in Windows on your PC, whether directly connected, or networked to your PC.

1. Select the Printer icon from the Control panel in the System screen, or the **Print setup** command from the printing commands on the **File** menu in the program from which you want to print.
2. If you are printing from within a program, press the **Printer** button.
3. Select 'Printer via PC' as the method via which you want to print.

You can now print a file using PsiWin to print via a PC. Refer to the PsiWin on-line help for more information.

Printing to a file

You can use the Series 7 to print a document to a file. To set up your Series 7 to print to a file:

1. Select the Printer icon from the Control panel in the System screen, or the **Print setup** command from printing commands on the **File** menu, in the program from which you want to print.
2. If necessary, press the **Printer** button. Select the printer model and select 'File' as the method via which you want to print.
3. Press the **Settings** button to specify the name of the file, and the folder and disk to which you want to print. Press **OK** to redisplay the Printer setup dialog.

When you print the file it will be saved in the file you specified in the Print to file dialog.

Important: Ensure that you use the correct filename, folder and disk drive. If a file of the same name already exists it will be deleted and replaced with the new file which you are printing.

Selecting the printer model

You can choose to print to various printer models. To select a printer:

1. Select the Printer icon from the Control panel in the System screen, or the **Print setup** command from the **Print** button or the **Printing** commands on the **File** menu, in one of the programs from which you can print.
2. If necessary, press the **Printer** button. Select the printer to which you want to print.
3. If required, change the method via which you want to print.

Note: When printing via a PC, you can only change the printer model on the PC. Refer to the PsiWin on-line help for more information.

Page setup

You can change the size of the page and specify other layout settings by selecting the **Page setup** command from the **Print** button or **Printing** commands on the **File** menu:

- Select the size of the page on which you want to print (e.g. A4) and the page orientation. If the page size you require is not in the list of sizes, select 'Custom', and then type in the width and height of the page you want.
- Use the **Margins** page to change the distance between the edge of the paper and the text.
- Use the **Header** and **Footer** pages to enter the text that you'd like printed at the top and bottom of each page. You can format the header and footer text, and insert other information in it, including page numbers and the date.
- Use the **Other** page to specify where you want page numbering to begin in the document, and from which page you want to display the headers and footers.





Previewing a document

You can see how the document will look when printed by selecting the **Print preview** command from the **Print** button or the **Printing** commands on the **File** menu.

To select the page you want to preview press the **Go to** button and enter the number of the page you want to view.

You can change the setup of the printed page and preview from the **Print preview** dialog by pressing the **Setup** button to display a list of options:

- To change the layout of the page, select **Setup**.
- To specify the number of pages shown in the preview and whether you want to view the margins, select **Preview**.
- To change the printer model and method, select **Printer**.

Print preview

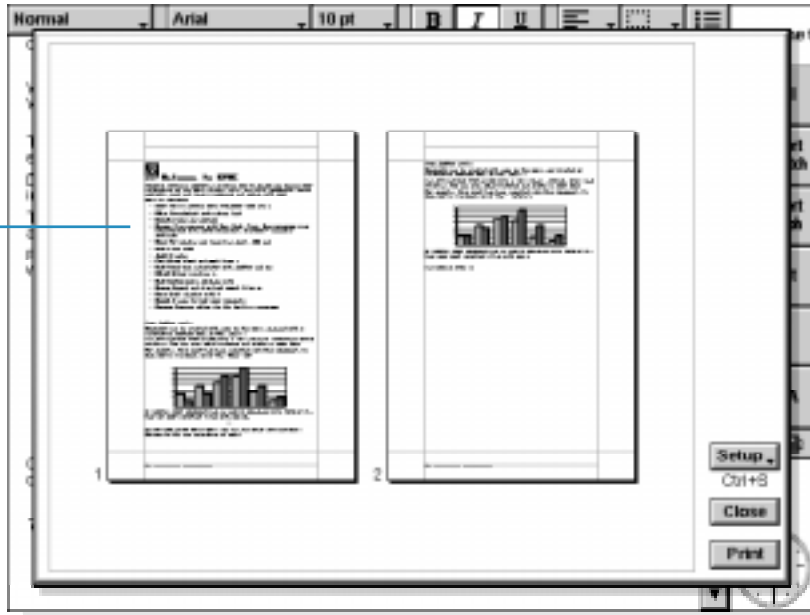

Printing a document

You can print out all or part of a document from the Contacts, Data, Agenda, Word, Sheet, Sketch and Program editor programs.

To do this:

1. Tap the **Print** button or select the command from the **Printing** commands on the **File** menu.
2. In the dialog you need to specify how many copies of the selected pages you want to print.:
(In Word you can also change the range of pages to print. If you don't change the range, one copy of the whole document will be printed.)
3. Press **OK** to start printing the document.





INFRARED

The Series 7 has Infrared built in, allowing you to transfer selected information to another Series 5/7 without the use of a cable.

You can also use Infrared to print directly to printers which support Infrared - see the 'Printing' chapter for more details.

⚡ Before you start.

Make sure that both machines are ready to communicate using Infrared. To do this, move to the System screen, then select **Remote link** from the **Tools** menu, and ensure that the **Link** line is set to 'Infrared'.

Ready to send
by infrared



Selecting data to transfer

On the machine **from** which information is to be transferred (the 'sending machine'), select the information you want to transfer:

- If the information is a file, ensure that the file is closed and highlight the filename on the System screen. Hold down the Shift key and tap additional filenames if you want to transfer more than one file.
- If the information is an object already inserted from another program, e.g. a graph displayed in Word, just select the object. If the inserted object is displayed as an icon, you can just select the icon.
- If the information is an Agenda or Data entry, open the appropriate file and move the cursor to the required entry.
- If you wish to transfer a graph, highlight the cell contents in Sheet view. Graphs cannot be transferred direct from one Sheet file to another, only the cell contents. Relative and absolute cell references are preserved.
- Otherwise, open the file from which the selected information is to be transferred, and select the required information (e.g. the piece of text, range of spreadsheet cells, sketch area).

Note: Objects can be transferred like other information. They appear as objects on the receiving machine.

Transferring the information

1. Ask the other user of the other Series 5/7 to open the program or file where the information is to be transferred **to**.
 - If the information to be transferred is an entire file, ask the other user to tap the System icon and move to the folder to which the file is to be transferred.
 - If the information is an Agenda or Data entry, ask the other user to open the appropriate Agenda or Data file.
 - Otherwise, ask the other user to open the file or program to which the selected information is to be transferred, and move the cursor to the appropriate point in the file.
2. On the receiving machine, tap the  command icon or select the **Infrared receive** command (or select it from the **Tools** menu). The "Ready to receive" screen will be displayed.
3. Position the two machines, aligning the Infrared windows (ideally, both should be resting on the same flat surface). The Infrared window on the Series 7 is on the back of the machine on the right-hand side when the Series 7 is open in front of you. **The machines should be no more than one metre apart.**





- On the sending machine, tap the  command icon and select the **Infrared send** command (or select it from the **Tools** menu). If the Infrared windows are in range, the transfer begins. Infrared screens appear on both machines to indicate that the transfer is taking place, and the progress of the transfer is displayed.

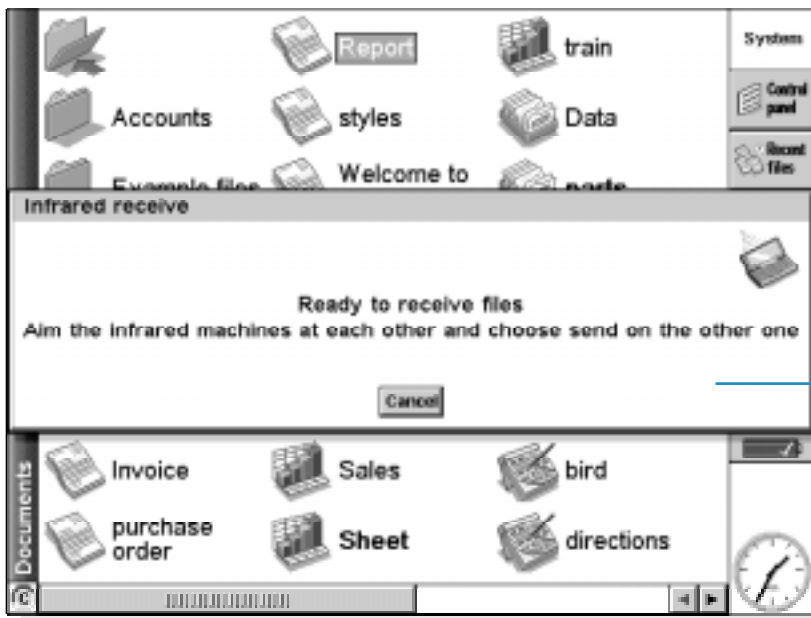

Ready to
receive by
infrared

When the transfer is complete

When the transfer is complete the Infrared screens disappear. There is now a copy of the selected information or file on the receiving machine.

Note: If a file is being transferred, and the folder on the receiving machine already contains a file of that name, then the receiving machine displays a dialog where you can rename the received file, or move it to another folder or disk drive.

The information on the sending machine is not affected by the transfer.

Cancelling the transfer

To stop the transfer while it is in progress, press Esc on either machine.

If the transfer fails

If the transfer fails, a message is displayed to indicate why. Follow the advice given by the message and try again.

Note: It is not possible to send information by Infrared between a Series 7 machine and a Series 3c/3mx or a Siena.

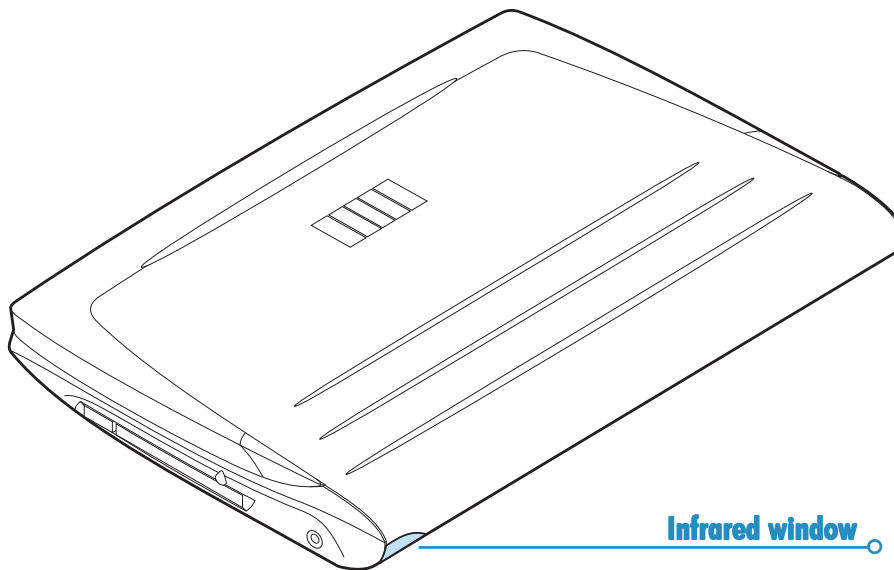

Infrared window





DIALLING

The Series 7 can generate the “DTMF” tones used for dialling telephone numbers. You can only use dialling from within the Contacts program, Agenda and Data.

Note: Phone systems do vary. DTMF dialling cannot be guaranteed to work with all types of phone.

You can dial a number as follows:

- If the number is included in a Contacts entry, select the entry and tap the **Dial** button on the Toolbar.
- If the number is already entered as part of a Contacts, Data or Agenda entry, you can just select the entry and use the Dial keypress (Fn+ Menu). The Series 7 will find the numbers in the entry so that you can select which number to dial.
- If the number is not already entered as part of a Contacts, Data or Agenda entry, you can use “free input” dialling where the Series 7 will dial the number as you type it.

Phone numbers in Contacts entry

Poore, Noel
Pozzilli, Christine and Tony

First name: Christine and Tony
Last name: Pozzilli
Mobile: 0962 353624
Home tel: 0181 979 9876
Home address: Merryweather Cottage
School Lane
Bushey
Herts

Dial

Mobile 0962353624
Home tel 01819799876

Cancel Free input... Dial Dial out
Esc Tab Space Enter

Find: go 2/2

Setting up

You can use free input dialling straight away, though you should remember to add any dial-out code (this is often a '9') required to obtain an outside line if you are calling from a building that has a private exchange.

If you have already entered a telephone number in Contacts, Data or Agenda, you can set up the Series 7 to include the dial-out code only when you need to. You can also set up the Series 7 so that the correct international prefixes and area codes are used when dialling.

To do this:

1. In the System Screen, tap on the **Control panel** button on the Toolbar or select the command from the Tools menu, and select the Dialling icon.
2. Tap the **Country** button and set the 'Country' to the country where you would normally dial non-international numbers, i.e. your country of residence. If you go abroad, change the 'Home city' but leave the 'Country' set as usual. The Series 7 will then be able to use the correct codes to dial numbers.
3. If you want to be able to dial out from an internal telephone exchange, e.g. from your office, enter the number you have to dial to get an outside line as a 'Dial out code'. If the internal telephone system requires a pause after the dial out code, add a comma after the number, and set the required pause time that will be used for each comma that you enter.

Entering phone numbers

You can enter a telephone number to dial in a Contacts, Data or Agenda entry.

In Data, you can set whether a label is checked when the Series 7 looks for telephone numbers to dial.

To include a label in the search: select the **Change labels** command from the **Tools** menu, select the label and press the **Edit** button. Then, press the **Options** button and tick the box to make sure that the label is searched when dialling. You can remove the tick if you do not want to search a particular label, perhaps if it contains other numerical information.

Note: If it appears that the Series 7 does not find a telephone number you have entered in a Data entry, it may be that the label is not being searched. Follow the instructions above to ensure that the label is included in the search.

Note: You can enter a telephone number anywhere in an Agenda entry, but try to avoid mixing telephone numbers and other numbers in the same entry.

For numbers in your own country, you should include the required area code in the telephone number. For international numbers, you should include the international prefix (or use a + instead) and the required national code. If you don't know the national code for a particular country, you can look it up in the Time program. You can use numerous other characters (e.g. brackets or a hyphen) to separate parts of the number. Do not use a comma as this represents a pause when dialling.





Dialling phone numbers

To dial a number already entered in the Contacts program, or in a Data or Agenda file:

1. Highlight the entry you want to dial from.
2. Press the Fn and Menu keys together, or tap the **Dial** button on the Toolbar in Contacts. The Series 7 will find up to five numbers in each entry.
3. Select the number you want to dial, and hold the Series 7 loudspeaker near to the telephone mouthpiece, approximately 2 inches (5 cm) away.
 - Press the **Dial** button to dial the number.
 - If you wish to use the dial out code, press the **Dial out** button to dial the number preceded by the dial out code.
 - You can change the number if it is not correct.
 - If you need to dial additional digits, press the **Free input** button to make the Series 7 dial the DTMF codes as you type each number.

To dial using free input dialling: press the Ctrl key with the Fn and Menu keys, then dial the number in the 'Free input' dialog. You can use the digits 0...9, *, and #. Press the **Redial** button to redial the number if necessary.

Note: The preset tone and delay times will normally be fine for dialling, unless you are using a poor quality telephone line. If dialling doesn't work in a particular location, try increasing the value of the 'Tone time' and 'Delay time'. Tone, Delay and Pause times are measured in units of 1/32 seconds.



CUSTOMISING YOUR SERIES 7

This chapter includes some ideas for customising the Series 7.

Note: You can customise the way many programs work using the **Preferences** commands on the program's **Tools** menu.

Creating your own wallpaper

You can change the “wallpaper” that appears in the background on the System screen. You can use any picture that you draw or import into Sketch.

To create wallpaper:

1. Display the picture in Sketch. If you only want to use part of a picture, select the area.
 2. Select **Save as System wallpaper** from the **More** commands on the **File** menu.
 3. Type a name for the wallpaper file. Sketch keeps the files that contain wallpaper separate from the original Sketch files so you can carry on using your original picture without affecting the wallpaper.
- **To select wallpaper:** move to the System screen and select **Preferences** from the **Tools** menu, then select the name of the wallpaper file that you want to display.
 - **To delete a file containing wallpaper:** move to Sketch and select **Delete System wallpaper** from the **More** commands on the **File** menu. Select the wallpaper that you want to remove. You cannot delete the built-in wallpaper included with the Series 7.

Recording your own alarms

You can use the Record program to create alarm sounds which can be used in Time and Agenda.

- **To save a recording for use as an alarm sound:** select the **Save as alarm** button on the Toolbar or the command from the **File** menu and type a name for the alarm sound. This creates another version of the sound as an alarm, and leaves the original file open in Record.
- **To delete a custom alarm sound:** select the **Delete alarm sound** command from the **File** menu, and select the alarm to delete from the list. You cannot delete or modify the built-in Series 7 alarm sounds.

Customising the System screen

You can use the commands on the **View** menu to change how the System screen looks and works:

- change the position of the Title by selecting **Title position**, and the width of the columns by selecting **Column width**.
- use **Zoom in** and **Zoom out** to change the size of text and icons on screen so that more or fewer files and folders are displayed.
- turn the Toolbar off and on with **Show toolbar**; without the Toolbar you can see more of the System screen.
- control how the files are sorted, and what file information is displayed with **Sort files** and **Show file details**. When you first use the Series 7, files are grouped ‘by type’ (i.e. according to program); you can change this to sort them by date, name or size.

You can customise many of the ways that the Series 7 works from the System screen using the **Preferences** command and the icons in the **Control panel**. For example, you might want to change the automatic switch off setting, owner information, the

standard printer and print preview settings, and set up a password to protect your files from prying eyes.

You can customise the positions of icons on the Extras bar, e.g. so that the icons for your favourite programs appear in particular positions. To display a dialog where you can set this, press the Enter key when the Extras bar is displayed, or tap the word “Extras” on the left of the Extras bar.

You can also allocate the programs in the Extras bar to the User definable icons on the left hand side of the screen.

✍ When a program is allocated to one of the User App buttons, it will no longer appear on the Extras bar.

The System screen preferences allow you to display “hidden” files and the “System” folder in the System screen, change the standard folder for files, and change the keypress for opening multiple files.

✍ *Caution:*

The “System” folder contains files that are used by the Series 7 programs themselves. You should not normally need to access these files, which is why this folder is not shown as standard. **Do not delete or modify files in this folder, or create new files in this folder, otherwise you may have problems using the Series 7 programs.**

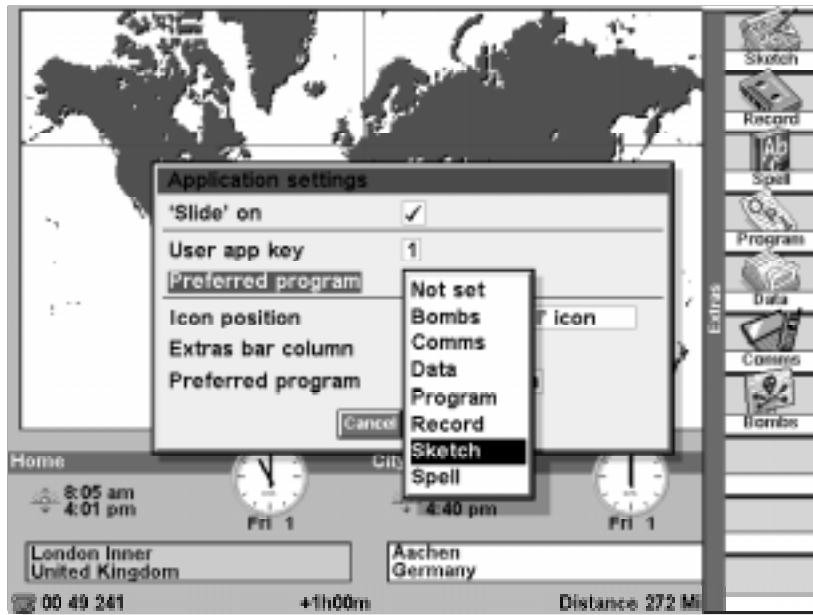

EXPANDING YOUR SERIES 7

This chapter includes some ways in which you can expand the capabilities of the Series 7.

CF Card

The CF card interface accepts type I and type II cards. Compact Flash cards are a cheap and convenient way to extend the storage capacity of your Series 7. Psion Memory Disks are available in this format as 4MB, 10MB 15MB AND 20MB sizes. These disks can be used to extend the file storage capacity and add additional applications. Because the Memory Disks use a type of memory called 'Flash', it can hold its contents even when outside the Series 7, so is ideal for making a backup which can be carried with you.

CF cards can also be used for high capacity storage devices like the IBM Microdrive, which is a miniature hard disk drive that offers massive storage capacity.

To get access to the CF card interface, carefully slide out the CF tray (on the left hand side, below the on/off switch). There is a groove on the bottom of the moulding to help this to be prised open.

It is important not to pull the tray out beyond the point where the finger hole is completely visible.

The CF card is installed by placing it in the tray, with the connector end going into the machine first. The tray will only close if the card is inserted correctly. When the card is in place, it can be accessed as drive D on the System screen. If the disk contains programs, these will appear as icons on the extras tool bar.

To remove a card, carefully slide out the tray and push the card out of the tray from below using the finger hole.

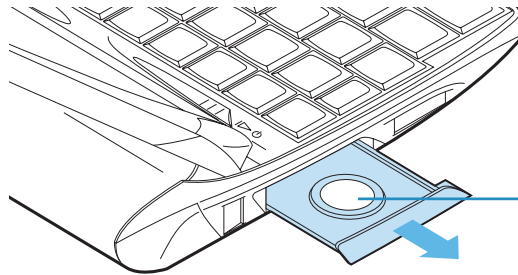

**Pull CF card tray
until finger hole
is visible**

PC Card

The PC card interface accepts type I and type II cards. Type I PC cards are used for storage of files and additional applications. Type II PC cards can be used for additional hardware - modems for instance.

The PC card slot is located on the right hand side below the pen holder. If no card is fitted to the slot, a 'blank' is fitted to stop the ingress of foreign objects. Before plugging a device into the PC card interface, you must first eject the 'blank' card. To do this, hinge the PC card eject button out from the case until

pointing straight out and push it in. The card will then be ejected. Withdraw this completely and insert your new device. The card should be inserted face up and pushed in until flush with the casing. The PC card eject button should be folded away to prevent accidental removal.

If the device is a Memory Card, it will be added as a new drive and can be accessed in the System screen. If the new card is a device such as a modem, the type needs to be set in the **Modems** entry of the **Control Panel**.

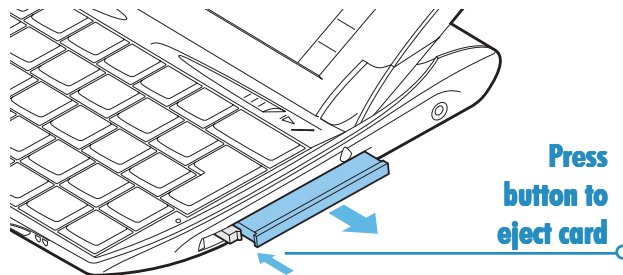
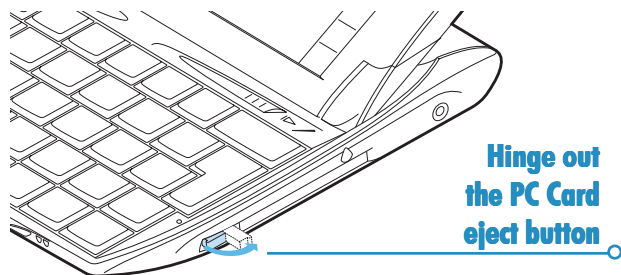

RAM cards

Your Series 7 is fitted with 16MB of RAM. This can be expanded to 32MB by adding a further 16MB RAM card.

The memory cards and circuitry under the memory card doors are susceptible to damage by Electro-Static Discharge (ESD). Memory upgrades should be trusted to an authorised service agent. Please call Level One on xxxxxxxxxxxxxxxx for details.

Note: As this upgrade will require all power to be removed, it is important to back up your data first.

RAM card slot cover

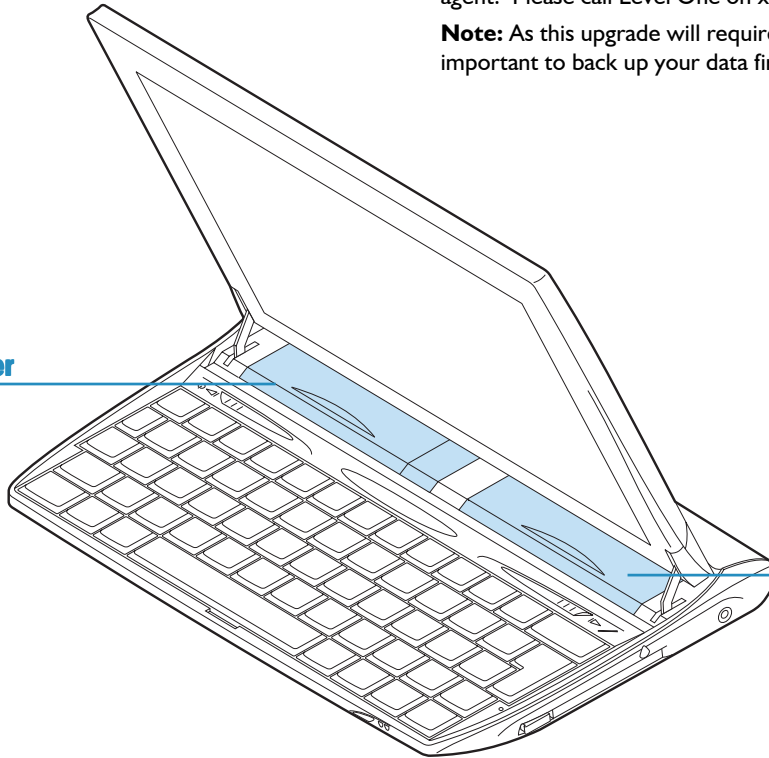

ROM card slot cover

CARE & SAFETY

When used according to the instructions in this manual, the Series 7 should remain in good working order for many years. However, there are certain precautions you should take to ensure continued trouble-free use:

- **Do** keep the Series 7 at a room temperature of 0°C to +40°C (+32°F to +104°F) and avoid sudden extremes in temperature, exposure to direct sunlight or rain, heat sources (electric heaters, etc.), dust, sand, and other fine particles.
- **Do** keep the Series 7 away from strong magnetic fields (e.g. loudspeakers) and sources of static electricity.
- Use only the Psion-approved mains adaptor.
- If you will not be using the Series 7 for a while, store it in a place that is dry, free from damp, dust and extremes of heat and cold.
- **Do** back up regularly. You can use PsiWin to back up your Series 7 to your PC, or you can make backups on a Memory disk. See the 'Security & backups' chapter for more information.
- **To clean the screen:** switch the Series 7 off and use a soft, clean, dry cloth to gently wipe the keyboard and screen. **Under no circumstances use water or chemical solvents that may have a corrosive effect.** (If the Series 7 is set to turn on automatically when you open the case or tap the screen, you should turn this preference off before cleaning the screen; see 'Turning on & off' for more information.)
- **Do not** tap the screen with any object that has a sharp tip or you may damage the screen. Don't use any type of ink pen, as the ink may be impossible to remove. When not in use, keep the pen supplied with the Series 7 in its storage compartment.
- **Do not** immerse the Series 7 in water, or any other liquid, or spill liquids onto it.
- **Do not** drop, throw, or try to bend the Series 7, or press the keys with extreme force.
- **Do not** keep the Series 7 next to credit cards or transport tickets; the speaker magnet could corrupt the information on the magnetic strip.
- **Do not** attempt to dismantle the Series 7. There are no user-serviceable parts inside and any attempt to do so will render the warranty void.
- **Do not** remove the main batteries and backup battery at the same time when replacing them; **you will lose all your information if you do this.**

Powering the Series 7

- Your Series 7 is powered by a powerful Lithium Ion battery pack which under normal operating conditions will provide power for 9 hours use. (See Prolonging battery life).
- Series 7 can be powered from the mains adaptor. When the Series 7 is powered this way, it will also charge the battery pack. The Series 7 should be connected to the mains adaptor as soon as you start getting the low battery message. If using your Series 7 for extended periods when you are unable to use mains power, it's best to keep two battery packs. Contact your Psion distributor for details.
- Backup power is provided by a lithium coin cell. This provides power when the main battery pack is being changed and will only provide a few days backup.



Backup Batteries recommended by Psion:

Duracell DL2032, Hitachi Maxell CR2032, Panasonic CR2032, Sony CR2032, Ultralife CR2032, Varta CR2032.



How do I check the battery power?

To check the battery power, move to the System screen and select **Battery** from the **Information** menu.

Changing the batteries

If you are using your Series 7 away from the charger for more than 8 hours continuous use, and have a spare battery pack, you can change it when the battery warning is displayed.

To do this:

1. Ensure that the backup battery is fitted and in good condition.
2. Switch the Series 7 off.
3. Slide the battery door backwards and withdraw the battery pack.
4. Slide in the replacement battery pack.

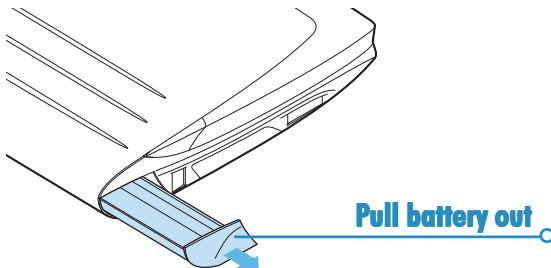
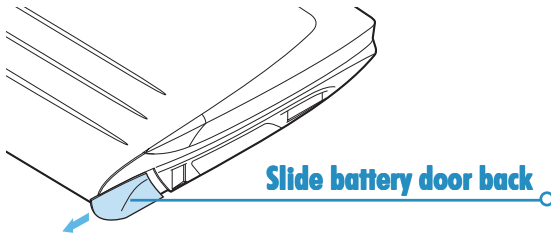

The Series 7 will warn you when the main battery charge is low or if the backup battery needs replacing. The backup battery compartment is designed to be “child-proof”; you will need to use the pen to remove the backup battery, as shown.

- If both the main and backup batteries are low, replace the backup battery first. If the main batteries are so low that you cannot turn the Series 7 on connect the Series 7 to mains power using the mains adaptor **before** changing the backup battery.

Important:

Never remove the main and the backup batteries at the same time. If you remove all power from your Series 7, **you will lose all of your information.**

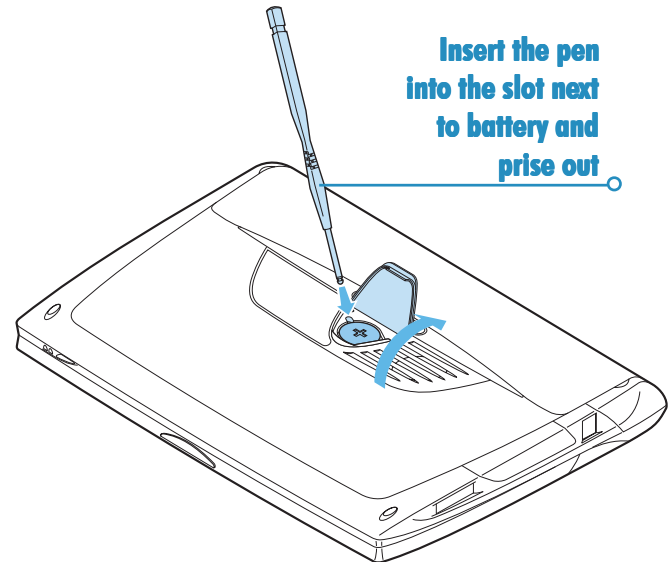

Battery safety

- Always observe correct polarity of batteries (+ and -) when inserting them.
- Don't store batteries at temperatures in excess of +60°C; the optimum storage temperature for maximum battery life is +10°C to +35°C.
- Don't dispose of batteries in a fire - there is a danger of explosion.
- Don't crush, puncture, open, dismantle, or otherwise mechanically interfere with batteries.
- If a battery should leak, do not allow the contents to come into contact with your skin or your eyes. If it does, wash immediately with plenty of cold water and seek medical advice.
- If a battery has been accidentally swallowed, it is **ESSENTIAL** that medical assistance is sought **IMMEDIATELY**. If the small backup battery has been swallowed, advise the medical person that a **LITHIUM** battery is involved.



Caution:

There is a danger of explosion if the backup battery is incorrectly replaced. Replace battery only with the same or equivalent type recommended by Psion. Dispose of used batteries according to the manufacturer's instructions.

Prolonging battery life

You can take steps to help your batteries last longer:

- Turn off the remote link when not in use.
- Set Auto switch-off.
- Use Data and Agenda files on the Internal disk (C) instead of a Memory disk (D), as the Series 7 requires more power to write to the Memory disk.

When your Series 7 is switched off, it is on “**standby**” and will continue to use a small amount of battery power. If you are going to leave your Series 7 switched off for a long period of time, you are advised to back up your data beforehand as the batteries will eventually run out.

How long your batteries last will depend upon how you use your Series 7. Your Series 7 will use considerably more battery power when you are recording sounds, have the brightness turned up, are using files stored on a Memory disk, or are using Infrared.

Note: To check the battery power, move to the System screen and select **Battery** from the **Information** menu.



SECURITY & BACKUPS

There are no known problems with passing the Series 7 through airport security machines and other X-rays.

There are several things that you can do to secure your files against other hazards. You can make your files “read-only” to avoid accidental deletion; back up your files regularly in case they get lost; set passwords to protect information from prying eyes and enter contact information so that your Series 7 can be returned to you if you lose it.

Note: It isn't possible for anyone to copy information from or to your machine using Infrared, unless they are able to access its Infrared 'Send' and 'Receive' commands.



Backing up to a PC

You can use PsiWin to back up individual files or folders, the Series 7's entire Internal disk, or files on Memory disks to the PC.

See the PsiWin on-line help for details.

Backing up to Memory Disks

You can back up individual files, individual folders or groups of files and folders to a Memory Disk. To back up the files and folders, copy them from the internal disk to a Memory Disk using the **Copy** and **Paste** commands in the system screen.

1. Select the files and folders you want to back up, then select the **Copy** command from the **Edit** menu.
2. Set the current disk to be D (i.e. the Memory disk), and select the folder you want to use for the backup on disk D.
3. Select the **Paste** command from the **Edit** menu.

Restoring files from a backup

To restore the files and folders on a Memory Disk to your Series 7, copy them from the Memory Disk to the Internal disk in the same way as backing up. This time, set the current disk to D to select the files on the Memory disk, then change it to C to paste the copied files to the Internal disk.



TROUBLESHOOTING

You should read this chapter if you have any questions or experience problems using your Series 7.

If an alarm doesn't ring

If the alarm sounds like beeps, your battery is too low to play the alarm sound you have chosen.

It may also be that the 'Sound' is off so that the alarm screen is displayed but the sound is inaudible. The alarm screen will indicate if the sound is off or silenced for a particular period. Use the **Sound** icon from the **Control panel** in the System screen to switch the sound back on again.

If an alarm is due to ring while you are recording another sound, the alarm will be postponed until you have finished your recording.

If world times don't seem to be correct in the Time program

This is likely to be because of "daylight saving" or "summer time" settings (where clocks are put forward for the summer months).

The dates that clocks are set to change vary from country to country, and sometimes even within a country; some countries do not use summer times at all. Therefore, the Series 7 clock will not change automatically on the date that the clocks change. You will need to make sure that each zone is set to use its "summer time" setting when the clocks change in those countries. See the 'Time' chapter for more details.

If a file appears to have “vanished”

When you tap on a program icon, the Series 7 will open the program with the file that you last used. If you only use one Agenda file, for example, this will always be displayed when you tap the Agenda icon.

However, if you move or rename your file, the Series 7 will not be able to find this “last used” file when you tap the program icon. So, it looks for a file with a standard filename (e.g. Word, Agenda, Sheet etc.) and displays this file instead. If there is no file with this name in the standard folder, a new file is created.

You can re-open the original file from its new location using the **Open file** command on the **File** menu.

If you forget your password

If you forget a password set for a Word or Sheet file, you will not be able to open the file again until you remember the correct password.

If you forget the password set for the whole machine, you will not be able to use the Series 7 until you perform a “hard reset”. All the files on the Internal disk will be lost and cannot be retrieved.

See ‘How do I reset the Series 7’ for more information.

If the Series 7 doesn’t seem to turn on/turn off

If the Series 7 doesn’t seem to turn on:

- Check the screen contrast to make sure it isn’t set too low.
- Recharge the battery. If you continue to use the Series 7 when the main battery is low, it will eventually not have enough power and will switch off. You will not be able to switch it on again until you connect the mains adapter and recharge the battery.

If the Series 7 doesn’t seem to turn off:

- Check the automatic switch off time using the **Switch on/off** icon from the Control panel in the System screen.

Note: If you use OPL, note that a running OPL program can prevent automatic switch off if it neither pauses or waits for a keypress.

If numbers appear on the screen when typing letters

It could be that the Numlock function has been set. To toggle the, press Shift + Menu.

How do I reset the Series 7?

If you find that you cannot exit a program normally, move to the System screen and select the **List open files** command from the File menu. Select the program from the list and press the **Close file** button.

If this does not work, or if your Series 7 appears to have “locked up”, you can always perform a “soft reset”. This should restart your Series 7 while preserving most of your information.

It is worth trying a soft reset if the keys on the Series 7 do not appear to respond, or if the Series 7 does appear to switch on and you are sure the batteries are good (especially if the contrast adjustment still appears to work), but the screen is otherwise blank.

- **To perform a soft reset:** gently press something like an unfolded paperclip into the reset hole, above the backup battery location.

After a soft reset, any changes to open Word or Sheet files (or OPL programs) will be lost. Your other files on the Internal disk will almost always be safe.

It is possible (although unlikely) that a program failure causes the reset to lose the information on the Internal disk; it could even prevent the reset from working at all. If this happens, you will have to perform a “hard reset”.

- **To perform a hard reset:** remove all power sources, ie the mains adapter and the main and backup batteries.

Important: A hard reset resets the Series 7 completely, and **all information on the Internal disk will be lost.**

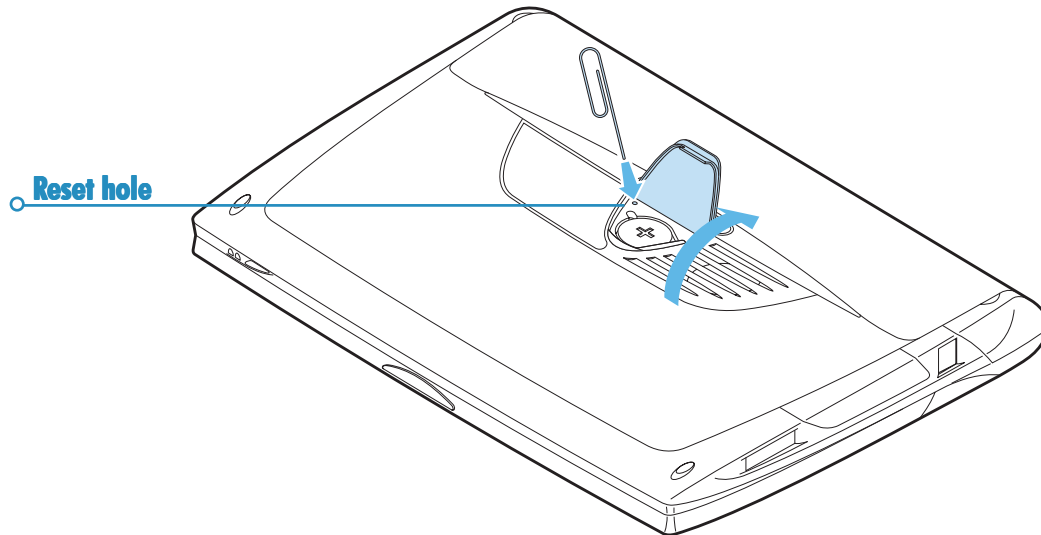

If you can't connect your cable

If you are having difficulty connecting the cable to your Series 7, you may be attempting to insert the connector upside down. Make sure that the “RS232” motif is facing **up** when you insert the connector. You should not have to apply force when inserting the connector into the port on your Series 7.

If you cannot solve your problem

If you are not able to solve a problem by referring to the pages of this user guide, the on-line help and the help and guides on the PsiWin CD, further support is available as follows:

Telephone	0990 143061
Faxback service	0891 515432 calls charged at 50p/minute.
Email	uk-support@psion.com”

APPENDICES

Character set

The Series 7 contains several fonts, but all have the same basic character set. This is the **IBM Code Page 1252** character set.

In addition to the characters that you can enter directly from the keyboard, there are many other special characters which you can use. You can display and insert them using the **Insert special character** command in the Word program.

To insert special characters in Word:

1. Open the Word file.
2. Select the **Special character** command from the **Insert** menu.
3. Select the required character and press OK.

Note: You can also use the Shift+Ctrl+C shortcut keypress to display the Special character dialog when typing text in most other programs.

To insert special characters when you can't display the Special character dialog:

1. Move to Word, select the **Special character** command from the **Insert** menu.
2. Move the highlight to the character you want to insert to display its shortcut key at the bottom of the dialog, e.g. the special character TM has the shortcut Ctrl+I53.
3. Move back to the program in which you want to insert the character and press its shortcut key, e.g. to insert TM hold down Ctrl and press I, then 5 and then 3.

IBM codepage 1252

	032	7	055	N	078	e	0101		0124	“	0147	ª	0170	Á	0193	Ø	0216	ï	0239
!	033	8	056	O	079	f	0102	}	0125	”	0148	«	0171	Â	0194	Ù	0217	ð	0240
“	034	9	057	P	080	g	0103	~	0126	•	0149	¬	0172	Ã	0195	Ú	0218	ñ	0241
#	035	:	058	Q	081	h	0104		0127	–	0150	-	0173	Ä	0196	Û	0219	ò	0242
\$	036	;	059	R	082	i	0105		0128	—	0151	®	0174	Å	0197	Ü	0220	ó	0243
%	037	<	060	S	083	j	0106		0129	~	0152	-	0175	Æ	0198	Ý	0221	ô	0244
&	038	=	061	T	084	k	0107	,	0130	™	0153	°	0176	Ç	0199	Þ	0222	õ	0245
‘	039	>	062	U	085	l	0108	f	0131	š	0154	±	0177	È	0200	ß	0223	ö	0246
(040	?	063	V	086	m	0109	..	0132	>	0155	²	0178	É	0201	à	0224	÷	0247
)	041	@	064	W	087	n	0110	...	0133	œ	0156	³	0179	Ê	0202	á	0225	ø	0248
*	042	A	065	X	088	o	0111	†	0134		0157	´	0180	Ë	0203	â	0226	ù	0249
+	043	B	066	Y	089	p	0112	‡	0135		0158	µ	0181	Ì	0204	ã	0227	ú	0250
,	044	C	067	Z	090	q	0113	^	0136	ÿ	0159	¶	0182	Í	0205	ä	0228	û	0251
-	045	D	068	[091	r	0114	%	0137		0160	·	0183	Î	0206	å	0229	ü	0252
.	046	E	069	\	092	s	0115	Š	0138	i	0161	,	0184	Ï	0207	æ	0230	ý	0253
/	047	F	070]	093	t	0116	<	0139	ç	0162	¹	0185	Ð	0208	ç	0231	þ	0254
0	048	G	071	^	094	u	0117	œ	0140	£	0163	º	0186	Ñ	0209	è	0232	ÿ	0255
1	049	H	072	_	095	v	0118		0141	¤	0164	»	0187	Ò	0210	é	0233		
2	050	I	073	`	096	w	0119		0142	¥	0165	¼	0188	Ó	0211	ê	0234		
3	051	J	074	a	097	x	0120		0143	¦	0166	½	0189	Ô	0212	ë	0235		
4	052	K	075	b	098	y	0121		0144	§	0167	¾	0190	Õ	0213	ì	0236		
5	053	L	076	c	099	z	0122	‘	0145	¨	0168	¿	0191	Ö	0214	í	0237		
6	054	M	077	d	0100	{	0123	’	0146	©	0169	À	0192	×	0215	î	0238		

Specification

Dimensions:

Size: 235×182×37 mm.

Weight: 1150g.

Screen: 7.7" 640x480 colour STN LCD panel

Colour full VGA

15 touch-sensitive icons for program selection.

5 touch-sensitive icons for commands.

Internal memory:

ROM: 12MB, containing multi-tasking, windowed operating system.

RAM: 16MB.

Note: Information correct at time of print. Memory configurations may vary according to model (see product packaging for details).

Expansion:

CF card interface accepts Psion Memory Disks/Program disks (Compact Flash Type I) and high capacity Microdrive (Compact Flash type II).

PC card interface accepts 3V/5V Type I and Type II PC cards.

Processor:

32bit StrongARM, SAI 100 @ 100MHz.

Sound:

Loudspeaker - ½W, 8 ohm.

Microphone - Electret with active gain control.

Power:

Lithium Ion battery pack 3x18650 cells giving 10.8V @ 1500mAh.

Standard Lithium (CR 2032) battery protects RAM while main batteries are changed.

Mains adapter (15V DC ± 10%, 1.5A).

Keyboard:

84 key, QWERTY layout, touch-type keyboard.

Operating temperature:

0-40 degrees Centigrade.

Communications options:

Fast RS232-compatible serial link provides data transfer speeds of up to 115200 baud.

IrDA SIR optical link supports Infrared communications.

Index

Symbols

- # sign
 - in Sheet 47
- » in Agenda 69
- \$ sign
 - in Sheet 48
- 12/24 hour clock 15, 138
- 3D graphs 53

A

- absolute references in Sheet 48
- accented characters 203
- adding
 - Agenda entries 63
 - anniversaries in Agenda 65
 - appointments 63
 - birthdays in Agenda 65
 - calculations in Calc 118
 - city 137
 - clipart to a Sketch 151
 - country 138
 - day entries in Agenda 63
 - entries in Contacts 55
 - entries in Data 142
 - entries in Jotter 125
 - event entries in Agenda 63
 - files to emails 109, 115
 - information in Sheet cells 46
 - labels in Contacts 57
 - labels in Data 146
 - memos in Agenda 72

- numbers in Calc 118
- passwords to files 29
- phone numbers 184
- pictures in Agenda 73
- programs 32
- scientific calculations 119
- text in Sketch 150
- titles to graphs 54
- to-do entries 69
- to-do lists in Agenda 70
- town or city 137
- voice notes in Agenda 73
- words to Spell 156
- addresses
 - in Email 109, 113
- Agenda
 - alarms 66
 - dialling 184
 - Infrared 180
 - moving & renaming files 30
 - PC agendas 5, 76
- alarms 131
 - changing 134
 - deleting 134, 187
 - in Agenda 65, 66
 - recording 187
 - responding to 132
 - setting 132
 - troubleshooting 199
- alignment
 - in Sheet 50
 - in Word 35
- alphabetical order in Contacts 55
- alphabetical order in Data 144

- am/pm clock 15
- anagrams 154
- analog clocks 138
- angle formats 123
- anniversaries in Agenda 65
- annual appointments 69
- applications. *See* programs
- applying styles in Word 37
- appointments in Agenda 63
- archiving Agenda files 74
- arrows
 - in menu commands 10
 - on dialog lines 10
- assigning memories in Calc 121
- attachments
 - adding 109, 115
 - opening/viewing 115
 - saving 115
- attributes 29
- automatic
 - send in Email 112
- automatic switch on/off 6
- axis titles 54

B

- background
 - screen. *See* wallpaper
- background colour in Word 36
- backing up
 - to a PC 5
 - to Memory disks 30
- backlight 7, 20
- backup
 - PsiWin 165
- backup battery 6
 - removing 195
- backups
 - files 19, 197
 - on Memory Disks 19, 197
 - on PCs 19
 - restoring 197
 - using PsiWin 171
- bar graphs 53
- batteries
 - checking power 194
 - prolonging life 196
 - recommended 194
 - safety information 196
 - types 6, 205
- BCC in Email 109
- beaming. *See* Infrared
- bell symbol in Agenda 65
- birthdays in Agenda 65
- blind copy in Email 109
- bold text
 - in Sheet 50
 - in System screen 7, 23
 - in Word 34
- Bombs game 161
- bookmark in System screen 21
- bookmarks
 - using in Web 96
- borders
 - in Sheet 50
 - in Word 36
- browsing folders 27

- bullets
 - in Jotter 126
- bullets in Word 35
- Busy view in Agenda 64
- buttons
 - in dialogs 12

C

- Calc program 117
- calculations
 - general 118
 - in Sheet 47
 - scientific 119
- calendar
 - in Agenda 67
 - in dialogs 12
- calibrating the screen 20
- cancelling
 - dialogs 12
 - Infrared transfer 182
- candle symbol in Agenda 65
- care of the Series 5 193
- categories in Agenda. *See*
 - entry symbols
- CC in Email 109
- centred text in Word 35
- CF card 189
- changing
 - Agenda entries 68
 - alarm details 134
 - angle formats 123
 - city details 137, 138
 - colours in Sketch 150

- Contact entries 57
- country details 138
- Data entries 144
- font in Word 34
- labels in Contacts 57, 58
- labels in Data 144, 145
- number formats in Calc 124
- templates 41

- character set 203
- check box 10
- circles & ellipses 148
- cities 131
 - adding 137
 - changing details 137, 138
 - deleting 137
 - selecting 136
 - sunrise and sunset times 139
- cleaning the screen 193
- clearing
 - alarms 132
 - the Calculator display 119
- clipart in Sketch 151
- clocks 138
- closing
 - email accounts 116
 - files 23
 - files & folders 23
 - programs 23
- colours in Word 34
- column graphs 53
- column widths
 - in Data 144
 - in System screen 187

- COM port
 - connecting 167
- combining information 12
- command icons 7
- commands on menus 10
- Comms program 19
- compiling an OPL program 164
- compressing
 - sounds 160
- confirming tentative Agenda
 - entries 63
- connecting
 - to mailboxes 111, 112
- connecting to PCs 5
- Contacts
 - dialling 184
- contacts
 - adding 55
 - deleting 57
 - editing 57
 - finding 56
 - labels 57
 - sorting 55
- contrast of screen 7, 20
- Control panel 15, 19
- converting files to PC programs 5
- cookies
 - in Web 105
- copying
 - Agenda entries 68
 - by Infrared 179
 - disks 30

- files & folders 30
- files with PSiWin 170
- text in Word 34
- words to spell check 153

- copying files
 - to Memory Disks 19, 197
- COS function 123
- countries
 - changing details 138
 - deleting 138
- creating
 - emails 109
 - fax & SMS messages 107
 - files 9, 25
 - folders 24, 27
 - graphs 52
 - Local folders 108
 - sketches 147
 - styles 38
 - templates 41
 - to-do lists 70
 - wallpaper 187
 - Word files 41
- cropping
 - in Sketch 150
 - objects in Jotter 128
 - objects in Word 41
- crossing out
 - Agenda entries 68
 - in Word 34
- crossword clues 155
- cube roots in Calc 123
- cubing numbers in Calc 123
- currency 20

customising

- Agenda 74
- Extras bar 188
- Jotter 129
- System screen 187
- to-do lists 71
- Web 95

cutting

- files & folders 30
- Sketch 150

D**daily appointments 69****Data 141**

- dialling 184
- Infrared 180
- labels 184
- moving & renaming files 30

date 136

- format 20, 138
- setting 15

day entries in Agenda 63**daylight saving time 139****deadlines for To-do entries 69****decimal places in Calc 124****default printer 173****defining ranges in Sheet 49****degrees in Calc 123****deleting**

- Agenda entries 68
- alarms 134, 187
- cities 137
- Contact entries 57

country 138

- Data entries 144
- emails 112
- files & folders 30
- in Sketch 150
- Jotter entries 128
- styles 38
- wallpaper 187

deselecting files & folders 30**Desk view in Calc 118****detaching files from email 115****dial out codes 184****dialling 183**

- and Data labels 184
- codes 131
- free input dialling 185
- in Contacts 55
- troubleshooting 184

dialogs 10

- buttons 12
- cancelling 12
- saving settings 12

dictionaries in Spell 156**digital clocks 138****disabling alarms 134****disconnecting**

- in Email 116

disks

- copying 30
- formatting 32
- renaming 30
- root folder 23

displaying

- help 13
- non-printing characters 36

distance units 138**distances 136****dividing in Calc 118****DNS address**

- configuring 88

downloading. See receiving

- files in Web 99

Draft

- folder 108, 110

draft

- emails 110

drawing

- circles and ellipses 148
- in Sketch 147
- squares and rectangles 148
- tools in Sketch 147

DTMF dialling 183**due dates for To-do entries 69****E****editing**

- colours in Sketch 150
- Contact entries 57
- Data entries 144
- pictures in Agenda 73
- previous calculations in Calc 121
- repeat entries in Agenda 69

electronic mail. See Email**Email 107**

- account setup 78
- addresses 109, 113
- attachments 109, 115
- closing messages 113
- connecting 111, 112
- creating messages 109
- disconnecting 116
- finding out more 116
- forwarding 113
- message editor 109, 113
- on-line help 116
- receiving 112
- replying to 113
- requirements 107
- saving draft messages 110
- sending 111
- setting up 83, 116
- viewing messages 113

embedding. See inserting objects**Enter key 12****entry symbols in Agenda 74****erase tool in Sketch 150****Esc key 12****Expansion**

- Compact Flash Cards 189
- modem 190
- PC Card 190
- RAM card 191

exponents in Calc 124**Extras bar 23**

- and Memory disks 32
- customising 188

Extras icon 23

F

facsimile. *See* fax
factorials in Calc 124

Fax

requirements 107

fax

messages 107

file lists in System screen 187

file manager 21

filenames 25, 30

Files

missing 200

files

adding to emails 109, 115

Agenda 74

archiving Agenda files 74

attributes 29

backing up to Memory Disks
19, 197

backing up to PCs 19

browsing 27

closing 23

creating 9, 25

details 27

file sizes 31

finding 28, 200

highlighting 30

in System screen 9, 21, 24

Infrared transfer 180

managing 27, 30

merging 74

naming 25

opening 23, 25, 27

passwords 29

read-only 29

selecting 30

sorting 27, 187

transferring to PCs 24

files & icons 9

finding

Agenda entries 67

anagrams 154

dates in Agenda 67

entries in Contacts 56

entries in Data 144

help 13

in Sheet 46

Jotter entries 128

missing letters 155

synonyms 154

text in Web 104

text in Word 34

finding files 28, 200

Fixed number format 124

Flash

memory 189

flipping

layout in Calc 117

sketches 149

Fn key 23

folders

browsing 27

closing 23

creating 9, 24, 27

Draft 108, 110

highlighting 30

Inbox 108, 112

Local 108

managing 27, 30

names 21, 24

naming 25

opening 23

Outbox 108, 109, 110, 111

selecting 30

Sent 108, 112

types in Email 108

font

for Data labels 144

in Sheet 50

in Sketch 150

in Web 103

in Word 34

footers

in Page setup 176

in Word 43

forced line break 35

foreign characters 36, 203

formats

numbers in Calc 124

numbers in Sheet 51

time & date 20, 138

formatting

disks 32

objects in Jotter 128

objects in Word 41

paragraphs 35

text in Word 34

forms

using in Web 97

formulae 46

forwarding email 113

free input dialling 185

free memory 31

functions

in Calc 119

in Sheet 49

G

game 161

Glossary 80

GMT (Greenwich Mean Time)
137

going to entries in Agenda 67

gradients in Calc 123

graphs 52

in Jotter 128

in Word 40

Infrared 180

grey

dialog lines 10

menu commands 10

grid lines in Sheet 54

H

handshaking 175

hanging indents 35

hard hyphen in Word 36

hard reset 201

headers

in Page setup 176

in Word 43

Help

keypress 13

on Email 116

technical support 202

using 13

help

PsiWin 166

hidden

files 188

labels in Data 144

text in Word 36

highlighting

cells in Sheet 46

files & folders 30

text in Word 34

Home city 136

setting 15

when you travel 139

HTML

source in Web 106

hyperbolic functions in Calc 123**I****icons**

in Jotter 128

in System screen 9, 21

images

in Sketch 147

in Web 98

IMAP4

email configuration 91

Inbox

folder 108, 112

indents in Word 35**Infrared 179**

printing 174

security 197

inserting

date in Jotter 127

foreign characters 203

objects in Jotter 127

objects in Word 40

page breaks 43

installing programs 32**international**

dialling 137, 184

settings 20

Internet

account setup 78

connecting 111, 112

disconnecting 116

Internet service

setting up 86

IP address

configuring 88

IrObex standard 59**italic text**

in Sheet 50

in Word 34

J**Jotter 125**

adding entries 125

customising 129

finding entries 128

inserting objects 127

printing 130

K**keyboard**

settings 20

where things are 6

keypresses 20

in Web 101

keys

Enter 12

Esc 6, 12

Help 13

on & off 6

shortcuts 12

kilometres 138**L****labels**

in Contacts 57

in Data 145

left aligned text in Word 35**line graphs 53****line spacing in Word 36****lines in Sketch 148****listing open files 9, 23****Local**

mailbox 112

Local folders 107, 108**logarithms 124****loudspeaker 158****low batteries message 6****M****mail. See Email****mailbox**

connecting 111, 112

Local 112

Remote 107, 110, 112, 116

types in Email 107

mains adaptors 6, 193, 205**managing**

emails and folders 107

files & folders 27

map of the world 131**margins**

in Word 35

printing 176

memories in Calc

in Desk 118

Scientific 121

memory 31

Disks 189

gauge 31

information 31

RAM card 191

memory disks 32, 205

backups 19, 197

formatting 32

memos in Agenda 72**menus & menu commands 10****merging**

in Jotter 130

merging Agenda files 74**messages**

email, SMS and fax 107

microphone 157
midnight 15
miles 138
monthly appointments 69
moving

Agenda entries 68
Agenda files 30
an area in Sketch 149
Data files 30
files & folders 30

multiple files
and Infrared 180
multiple graphs 54
multiplying in Calc 118

N

names & addresses 55
naming ranges in Sheet 49
natural logarithms 124
natural numbers in Calc 124
nautical miles 138
navigating
Word files 39
non-breaking hyphen in Word 36
non-breaking space in Word 36
non-printing characters 36
Normal number format in Calc 124
notepad program 125

number formats
in Calc 124
in Sheet 51
number of years in Agenda 65

O

objects 180
combining information 12
in Word 40
on/off (switching on/off)
6, 20, 200
tapping an icon 6
open files 9, 23
opening
attachments 115
draft emails 110
emails 113
files 27
files & folders 7, 23
files from your PC 171
multiple files 23, 25, 188
operator precedence in Calc
Desk view 118
Scientific 120
operators in Calc 118
OPL 163
Outbox
folder 108, 109, 110, 111
outline navigation
in Word 38
owner information 17

P

page breaks in Word 43
page layout 176
margins 176
numbering 176
size of the page 176
page numbers in Word 43
paragraph
alignment 35
styles 37
parallel printers 174
password
files 29
system 17
passwords
forgotten 200
pasting
files & folders 30
PCs 5
backups 19
transferring files to 24
pen
finding & using 7
pen colour in Sketch 147
pen width in Sketch 148
pencilling in an Agenda entry 63
percentages in Calc 119
personal dictionary 156
phone numbers. See dialling

pictures
in Agenda 73
in Sketch 147
in Word 40
pie chart 53
pixels 148
POP3
email configuration 91
port settings 175
power. See batteries
powers in Calc 123
precedence in calculations 120
Preferences
Extras bar 188
in Jotter 129
in System screen 187, 188
preferences
in Jotter 129
printing 173
Agenda entries 75
Contacts entries 59
Data entries 146
documents 178
entry symbols in Agenda 75
in Jotter 130
in Word 44
previewing a document 177
selecting the printer model 176
setting up the printer 173
Sketch pictures 151
to a file 175
to a parallel printer 174
to a serial printer 175
using Infrared 174
via a PC 5, 175

priority of To-do entries 69
 Program editor 163
 program icons
 7, 9, 23, 32, 188
 program manager 21
 programs
 described 9
 running 9
 proxy servers
 using with Web 100
 PsiWin 5
 connecting 168
 CopyAnywhere 125
 copying files 170
 finding 165
 Installing 165
 synchronising Agenda 76

R

radians in Calc 123
 radio buttons 10
 ranges in Sheet 49
 re-sizing
 objects in Jotter 128
 re-using
 answers in Calc 121
 calculations in Calc 121
 read-only files 29
 recalculating a worksheet 49
 receiving
 emails 112
 reciprocals in Calc 123

recommended batteries 194
 Record program 157
 recording
 alarms 187
 sounds 157
 Relative references
 in Sheet 48
 relative references in Sheet 48
 reminders for Agenda entries
 65
 Remote
 mailbox 107, 110, 112, 116
 renaming
 disks 30
 files & folders 30
 labels in Contacts 58
 to-do lists 70
 repeat appointments 69
 repeat entries 69
 repeating sounds 158
 replacing text in Word 34
 replying to email 113
 resetting the Series 7 201
 resizing
 in Sketch 149
 objects in Word 41
 the background in Sketch 150
 responding to an alarm 132
 restoring backups 197
 reversing the layout in Calc 117
 reverting to saved
 in Word 43

right aligned text in Word 35
 root of disks 23
 roots in Calc 123
 rotating sketches 149
 running an OPL program 164

S

saving
 and switching off 6
 attachments 115
 dialog settings 12
 draft emails 110
 files 23
 web pages 94
 Scientific number format 124
 Scientific view in Calc 119
 screen
 backlight 7
 calibrating 20
 cleaning 193
 contrast 7
 settings 20
 size of text 7
 wallpaper 187
 searching
 in Jotter 128
 security
 Infrared 197
 Memory disks 29
 other machines 29
 PCs 29
 selecting
 all files & folders 30
 an area in Sketch 149
 cities & countries 136
 cities in one country 137
 files & folders 30
 menu commands 10
 sending
 by Infrared 179
 emails 111
 fax & SMS messages 107
 Sent
 folder 108, 112
 serial port
 connecting 167
 serial port settings 175
 serial printers 175
 Series 3/3a/3c/3mx
 upgrading files 5
 setting
 alarms 132
 alarms in Agenda 65
 dialling options 184
 Home city 15, 136
 passwords on files 29
 screen contrast 7
 summer time 139
 system password 17
 time & date 15, 136
 setting up
 Email 116
 setting up the Series 5 15
 shading cells in Sheet 50

- Sheet
 - Infrared 180
 - sorting 50
 - Sheet program 45
 - Short Message Service. *See* SMS
 - shortcut keys 12
 - in Calc 119
 - significant figures in Calc 124
 - silencing alarms 132, 134
 - SIN function 123
 - size
 - of files 27
 - text on screen 7
 - Sketch program 147
 - adding clipart 151
 - adding text 150
 - background size 148
 - circles & squares 148
 - cropping the picture 150
 - flipping & rotating 149
 - transparency 149
 - sketches
 - in Jotter 127
 - sketches in Word 40
 - SMS
 - messages 107
 - requirements 107
 - SMTTP
 - email configuration 90
 - snoozing an alarm 132
 - soft reset 201
 - solving
 - anagrams 154
 - crossword clues 155
 - sorting
 - entries in Contacts 55
 - entries in Data 144
 - files 27, 187
 - in Jotter 129
 - in Sheet 50
 - labels in Contacts 58
 - labels in Data 144
 - to-do lists 71
 - sounds
 - in Agenda 73
 - in Word 40
 - recording & playing 157
 - settings 20
 - special characters 36, 203
 - specification 205
 - spell checking 153
 - in Word 41
 - Spell program 153
 - spray painting in Sketch 148
 - spreadsheets 45
 - square roots in Calc 123
 - squares & rectangles in Sketch 148
 - squaring numbers in Calc 123
 - standby mode 196
 - start year in Agenda 65
 - status window. *See* toolbar
 - strikethrough. *See* crossing out
 - styles
 - and outline navigation 38
 - styles in Word 37
 - stylesheets. *See* template
 - stylus. *See* pen
 - subscript text 34
 - subtracting in Calc 118
 - summer time 139
 - sunrise and sunset times 139
 - superscript text 34
 - switching
 - auto switch off 6
 - backlight on & off 7
 - between files 23
 - on & off 6, 20
 - on/off and Jotter 126
 - tasks 23
 - symbol characters 203
 - symbols
 - in Jotter 126
 - symbols in Agenda 74
 - synchronising Agenda 76
 - Synchronizing
 - using PsiWin 172
 - synchronizing
 - PsiWin 165
 - synonyms 154
 - System folder 188
 - system password 17
 - System screen 21
 - introduction to 7
 - system settings 15
- ## T
- T symbol in Agenda 69
 - Tab key 12, 27
 - tables
 - in Sheet 45
 - in Word 40
 - sorting in Sheet 50
 - tabs in Word 35
 - TAN function 123
 - task list 23
 - telephone codes 137
 - telephone numbers. *See* dialling
 - templates
 - creating & changing 41
 - in Word 41
 - setting default 42
 - tentative entries in Agenda 63
 - testing alarms 132
 - text
 - adding to a sketch 150
 - colour in Word 34
 - entering in dialogs 10
 - size in Word 34
 - size on screen 7
 - thesaurus 154
 - things to do 69
 - tick box 10
 - tidying Agenda files 74
 - tilt roll in Calc 118

time

- 12/24 hour format 15
- am/pm clock 15
- format 20
- setting 15

time differences 136**Time program 131****timed entry in Agenda 63****times 131****title in System screen**

- 7, 21, 23, 31, 187

to-do entries 69**to-do lists 69**

- creating 70
- customising 71
- renaming 70
- sorting entries 71
- viewing 64

tone dialling 183**toolbars 187****transferring**

- files to PCs 24
- information by Infrared 179

translating an OPL program

164

transparency in Sketch 149**travelling 139****trigonometric functions 123****Troubleshooting 199****turning on/off 6****U****underlining**

- in Sheet 50
- in Word 34

undoing changes

- in Jotter 128
- in Sketch 150
- in Word 43

units of distance 138**updating Contact entries 57****updating Data entries 144****used memory 31****V****vCard standard in Contacts 59****viewing**

- alarms 135
- attachments 115
- emails 113
- entries in Data 143
- saved web pages 94
- views in Agenda 64

voice notes

- in Agenda 73

W**wallpaper**

- creating 187
- deleting 187

Web

- browser 92
- cache & memory usage 100
- connection status 102
- customising 95
- customising the display 101
- downloading files 99
- fonts 103
- keypresses 101
- loading images 98
- navigating 92
- plug-ins 106
- saving pages 94
- sending mail 104
- using bookmarks 96
- using forms 97
- using proxy servers 100

Week view in Agenda 64**weekly appointments 69****wildcards 56****windows. See dialogs****Word 33****Workdays 132****world map 131****wrapping text**

- in Word 34
- non-printing characters 36

writing. See creating**wysiwyg text 34****X****X-rays 197****X/Y scatter graphs 53****Xword in Spell 155****Y****Year planner in Agenda 64****yearly appointments 69****Z****zooming in & out 7, 187**

